

RADIO RETAILING

INCLUDING
SERVICE
AND
INSTALLATION
SECTION

THE BUSINESS MAGAZINE OF THE RADIO INDUSTRY

Victor Record Business Reaches a NEW HIGH!

Push Victor Records—enjoy the extra profits this business brings!

VICTOR Record business is now 68% better than it was last year and 110% over the year before! Sales have boomed higher than at any time during the past four years. And there's no reason to think the startling upturn will stop now! There are several sound reasons why still further startling increases are coming.

First, Victor has begun a new merchandising trend with its announcement of the Victor Library of Recorded Music—a completely new and unique creation that's making the public sit up and take notice. This library, containing 460 records in special albums housed in a beautiful cabinet, has not only impressed



the public with the necessity of good music to enhance the pleasure of home life, but has inspired the buying of individual records as well!

Second, a mighty advertising campaign has been in progress for over 18 months to make record prospects for you. Recently the schedule was increased by 300%! Four of America's most distinguished magazines are re-

ceiving double page spreads on the Victor Library. Newspaper rotogravure sections are also running announcements of it. Red Seal Albums are being advertised in 50 newspapers, four leading magazines every month! So push Victor Records—and watch your profits increase!



VICTOR RECORDS

RCA Manufacturing Co., Inc., Camden, New Jersey. A subsidiary of the
RADIO CORPORATION OF AMERICA



-and **Happy
New Year**

to our dealers: We pledge ourselves to maintain in Belmont receivers the highest quality of materials, the finest tone, the most attractive appearance, and the dependability which results in satisfied customers for you.

Model 1070

Features: Ten metal tubes in an advanced design for three channel all-wave reception; iron core i.f. stage for optional high-fidelity band expansion; ATC; 12" full dynamic speaker; a beautiful cabinet 41" high, 23" wide, and 12" deep for standard A.C. lines.

BELMONT RADIO CORPORATION
1257 FULLERTON AVE., CHICAGO, ILL.
CABLE ADDRESS: BELRAD

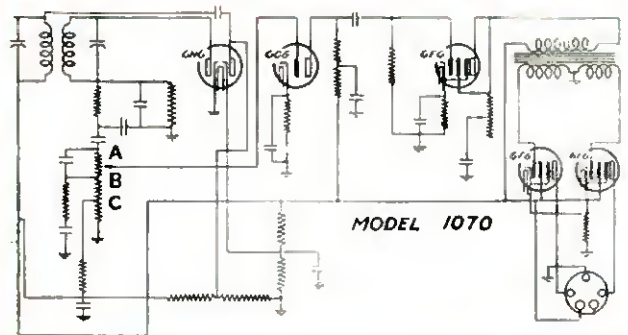

BELMONT
THE DEPENDABLE
RADIO

The powerful 25-watt class AB audio amplifier in the Belmont Model 1070 is preceded by an automatic acoustic tone compensating volume control. The adjacent curves show the frequency response at points A, B, and C on the tapped volume control in the diagram.

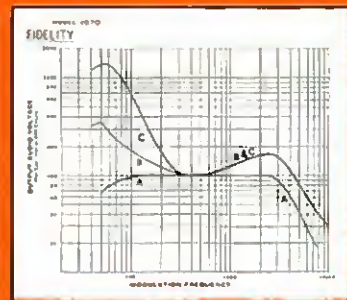

Acoustic compensated response curves

"Designed for Christmas Giving"—5 of the Famous 19 Models of

Emerson Radio

"RE-CREATES THE ARTIST IN YOUR HOME"



Featured Leaders of America's Most Successful Radio Merchants

Outselling all other radio in a price range of \$17.95 to \$129.95—combining STYLE with superlative performance—backed by powerful promotion—these and all other Emerson models are now the very backbone of the Christmas business of progressive dealers everywhere.

Make them YOUR leaders—give them the CENTRAL position in your holiday displays—they will carry your entire line.

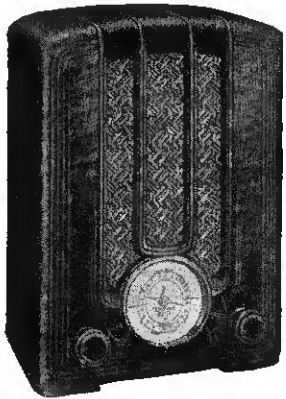

Model 108 . . . \$24.95
5-tube AC-DC 2-Band Superheterodyne in Bakelite cabinet.

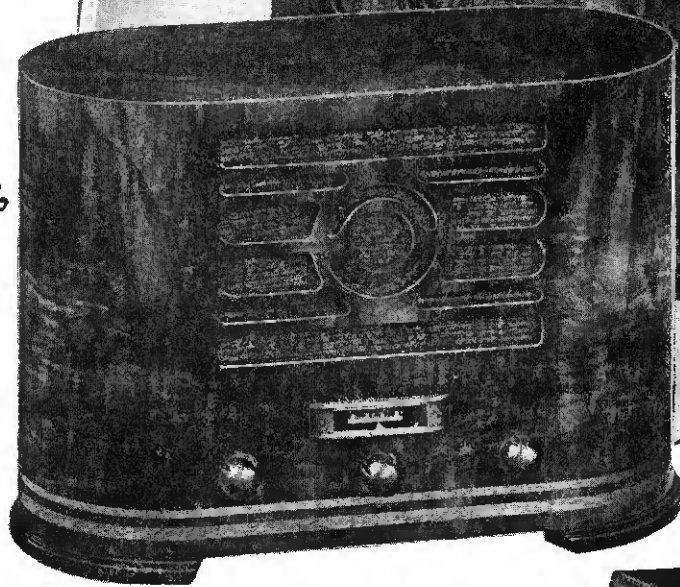

With METAL TUBES

Emerson "Duo-Tone" Model 106 . . . \$39.95
6-tube AC-DC Superheterodyne. Two bands. Identical front and back. Walnut cabinet.

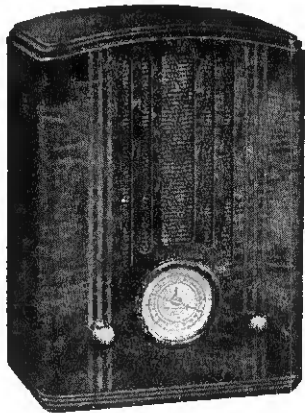

Model 110 . . . \$29.95
5-tube AC-DC 2-Band Superheterodyne in walnut cabinet.

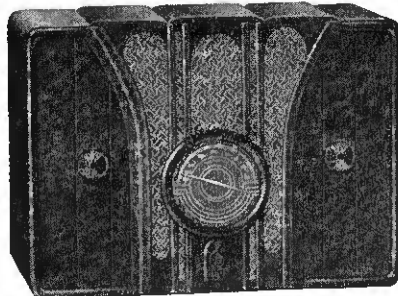

Model 109 . . . \$17.95
4-tube AC-DC Superheterodyne in Bakelite cabinet.

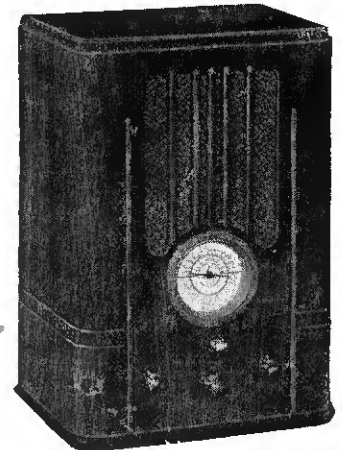

Model 34-C . . . \$44.95
6-tube AC Superheterodyne. American and Foreign — three bands.

EMERSON RADIO AND PHONOGRAPH CORPORATION, 111 Eighth Avenue, New York, N. Y.
The EMERSON Line Also Comprises Models for Every Foreign Market Cable Address: EMPHONOCO, N. Y.

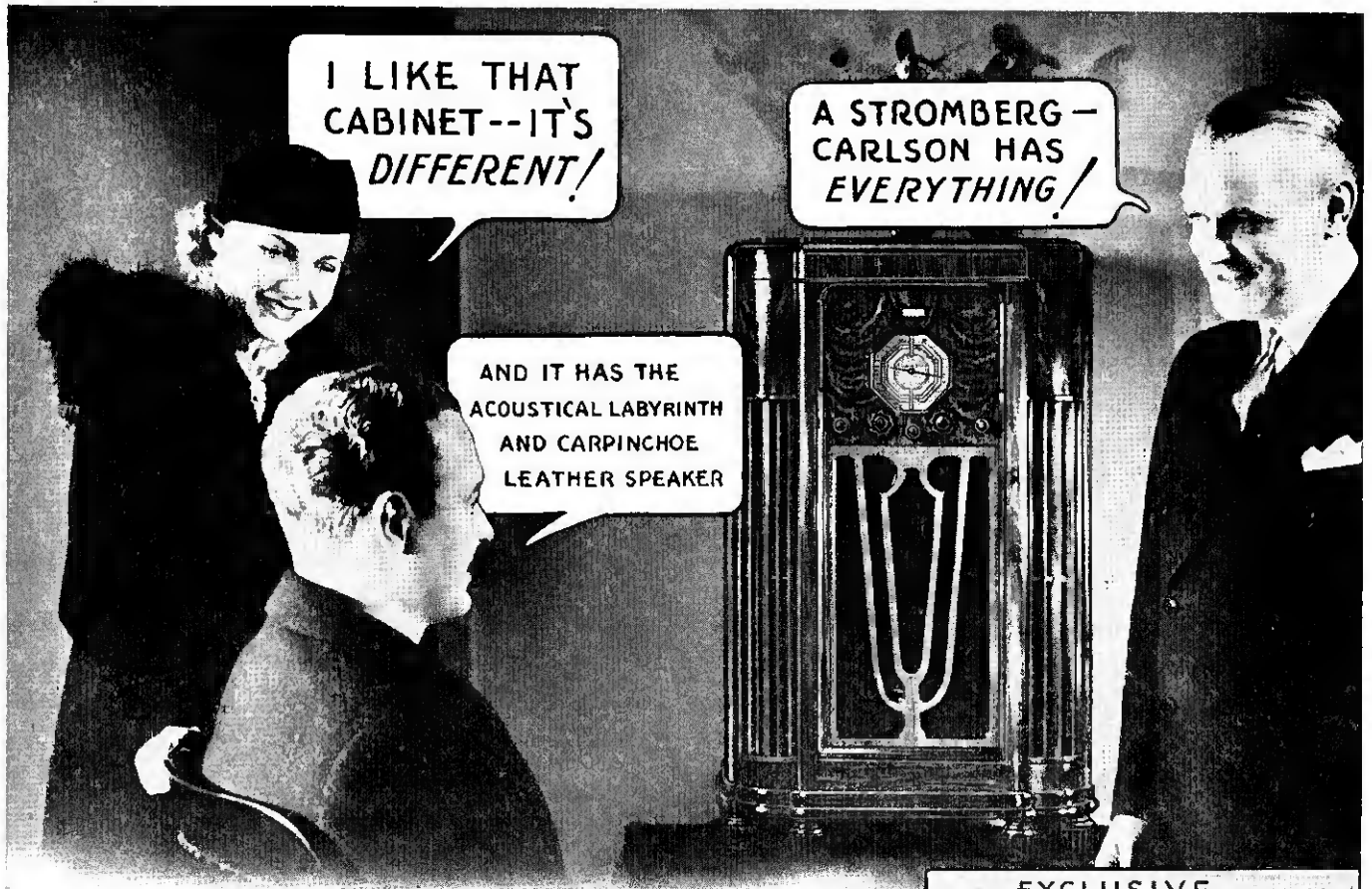

**EXCLUSIVE
STROMBERG-CARLSON
FEATURES**

IT'S not hard to understand why dealers find their Stromberg-Carlson sales jumping. Women demand them because of the original design of their cabinets as well as for their Natural Tone. Men prefer them because of the exclusive engineering achievements that make their performance outstanding in every detail.

The value of features like the Acoustical Labyrinth, Carpinchoe Leather Speaker, Dual Ratio Tuning Knob, Selectorlite Dial, Polydoroff Iron Core Transformers, Five-ply Non-warping Wood in cabinets, Rigidly Built Chassis and many others, are easy to demonstrate.

Stromberg-Carlson Dealers are cashing in on the real sales story they can tell for each of the sixteen models in the line.

The longest price range in the industry, \$59.50 to \$985 (Texas, Rockies and West, slightly higher). *There is Nothing Finer Than a Stromberg-Carlson.*

STROMBERG-CARLSON TELEPHONE MFG. CO., 100 CARLSON ROAD, ROCHESTER, N. Y.

The Acoustical Labyrinth — (Patent applied for)—makes possible absolutely true reproduction of bass tones (no boom), because it: (a) eliminates cabinet cavity resonance; (b) extends bass frequency response; (c) permits reproduction of larger volume tone without distortion; (d) projects sound from the front of cabinet only; (e) provides damping effect on speaker action after electrical impulses have stopped.

Carpinchoe Leather High Fidelity Speakers — This leather, from a wild South American boar, is used for speaker edge suspension. It is softer than chamois, yet unaffected by moisture and has the property of damping the natural resonance of the paper cone, thus ironing out peaks and valleys to give the smoothest, truest reproduction ever achieved in a single dynamic speaker covering the high fidelity musical range.

Illustrated are Stromberg-Carlson's seven High Fidelity Models (No. 84 at top).

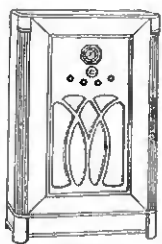

No. 62

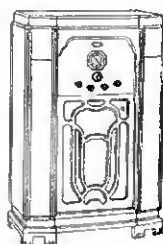

No. 63

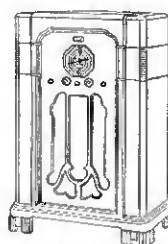

No. 83

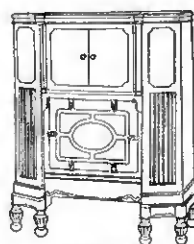

No. 70

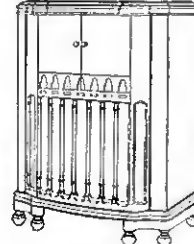

No. 72

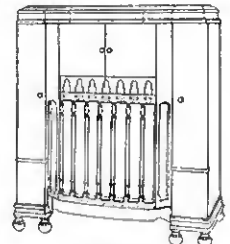

No. 74



Stromberg-Carlson



Ferrodyne

**WILL STILL BE RADIO NEWS WHEN METAL TUBES
BECOME AN OLD STORY**

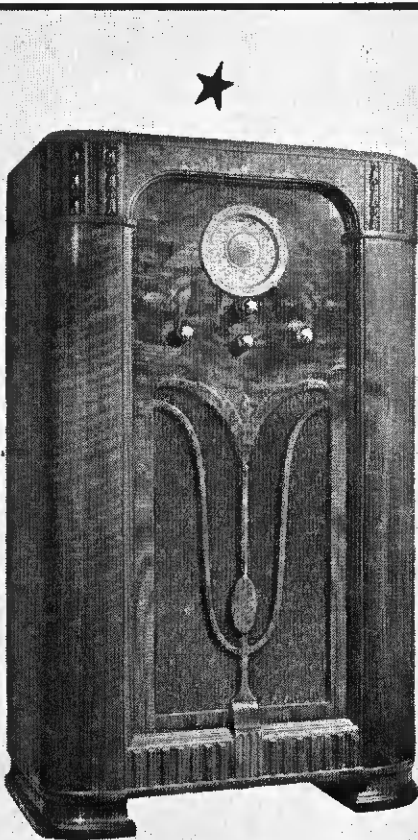

7-Tube Round-the-World Console

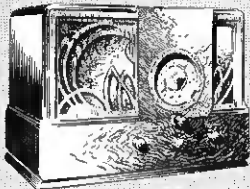

7-Tube Ferrodyne Table Model

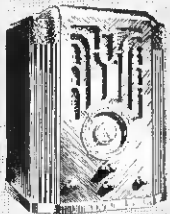

7-Tube Ferrodyne
Table Model

● Long after all-metal tubes become commonplace, the Ferrodyne radio will be a sales-producing story. For Stewart-Warner has the jump on the field—has developed the Ferrodyne radio especially for all-metal tube equipment—to give the listener *all* the advantages the all-metal tubes have to offer.

Radio experts agree that metal tubes are not interchangeable with old-fashioned glass tubes—that an entirely new *kind* of radio is needed. And that's just what Stewart-Warner has in the new Ferrodyne.

Almost every store on the street has metal tubes this year—and if *that's* all you have to offer, you'll have to compete with every radio dealer in town. But, with metal tubes—PLUS the new Ferrodyne radio—you're in a class by yourself. You have an exclusive combination that's cracking the replacement market wide open!

There's plenty of money in radio if you keep pace—so get the line you can sell to those who already own radio sets—the new Stewart-Warner Ferrodyne.

STEWART-WARNER CORPORATION
CHICAGO, ILLINOIS

Stewart-Warner Merchandising Plan Includes Your Own Radio Program

After you've heard the amazing Ferrodyne reception, look into the Stewart-Warner Merchandising Plan. Sound selling ideas are backed with newspaper advertising. And here's an exclusive scoop! You can have your own local radio program with big-time talent. So write, wire, or phone today—we'll gladly give you full details.

★ **STEWART-WARNER** ★

Ferrodyne **RADIO**

ATWATER KENT RADIO



**Keep this ringing all through
1936 with ATWATER KENT**

**WHY
DEALERS
MAKE
MORE
MONEY
WITH
TUNG-SOL
TUBES**

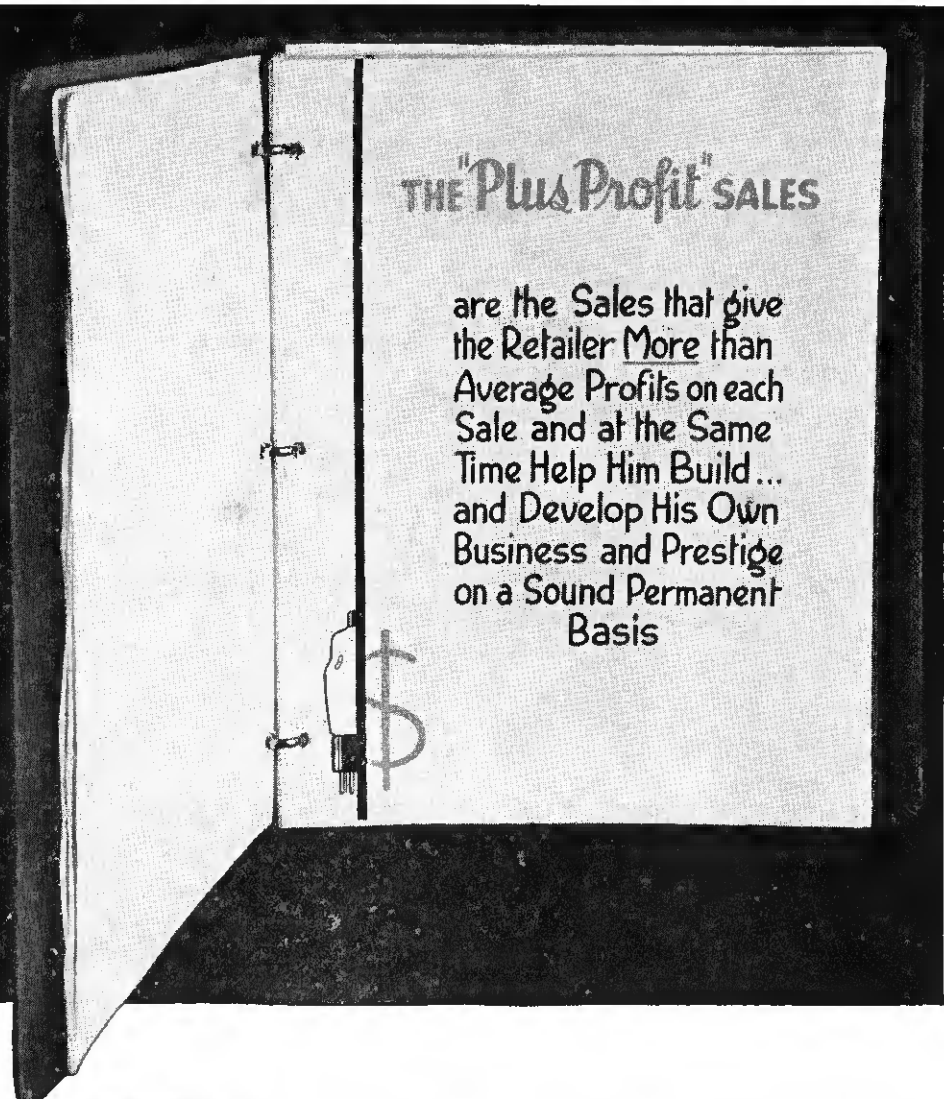

"Although I carry two other popular lines, I make more money on Tung-Sol than on either of the others."



RADIO CLINIC Inc.*
New York City

*Operates 3 stores with 20 repair men

TO produce "Plus-Profit" sales a tube line must have nine basic qualifications. They are developed and discussed in the above portfolio. It shows, in terms of your own experience, why all nine are necessary. And it demonstrates how each of these essential qualifications is doing its part to make Tung-Sol tubes the "plus-profit" line of thousands of Tung-Sol retail agents.

Go through this portfolio with the wholesaler for Tung-Sol who serves your locality. Discuss with him the possibility of your appointment as an authorized Tung-Sol agent. If you will write to our nearest sales office we will see that a representative calls promptly with a Tung-Sol portfolio.

TUNG-SOL
Tone-flow radio Tubes

TUNG-SOL LAMP WORKS, INC., Radio Tube Division
SALES OFFICES: Atlanta, Boston, Charlotte, Cleveland, Chicago, Dallas, Detroit, Kansas City, Los Angeles, New York. General Office, Newark, N. J.

IN A CLASS BY ITSELF

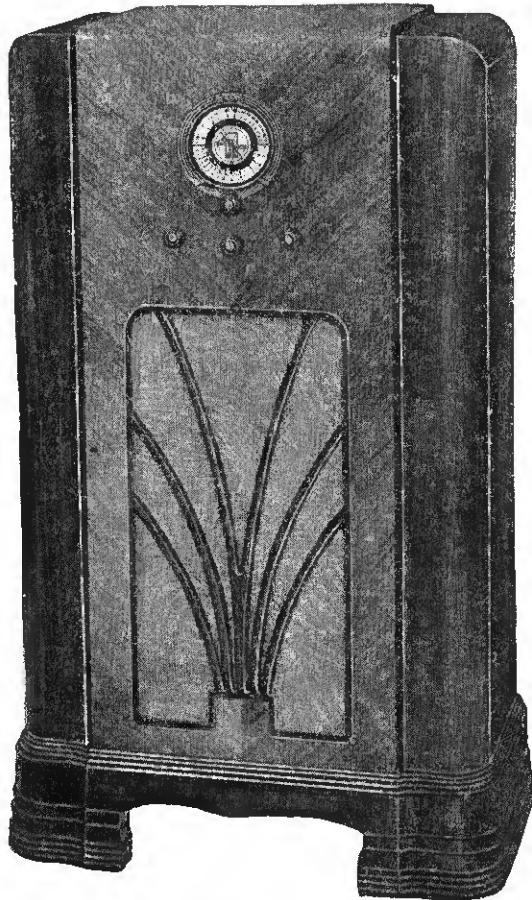

Console oversize model in piano finish Walnut—22½" wide—11½" deep—39½" high. Performs as well as it looks . . . But priced much lower than its looks deserve.

FADA No. 150 CA No. 160 CA

FIRST—in appearance—It's a dream to look at—a sleek, smooth thoroughbred.

FIRST—in performance—It has "it!" . . . With world-wide chassis covering all morning, afternoon and night-time broadcasts as low as 16 meters and a 10-inch full dynamic speaker—standard.

FIRST—in Price—Its amazing value smother competition. A big package of quality wrapped up with a fast moving price. It goes places!

No. 150 CA—5-tube AC world-wide Superheterodyne using metal tubes. 10-inch full dynamic speaker **\$59.95**

No. 160 CA—6 all-metal tubes, AC world-wide Superheterodyne. 10-inch full dynamic speaker . . **\$69.95**



FADA offers a radio for every purse . . . from compact to **HIFIDELITY** console . . . straight AC and AC-DC **WORLD-WIDE** receivers . . . from \$19.99 to \$144.50. Write for Distributor or Dealer proposition.

ANNOUNCING

FOR RURALITES WHO WANT FADA QUALITY

2 New Six Tube Air Cell Battery Operated Receivers—10 Tube Performance—World-Wide Tuning Range—Class B Output—Dynamic Speaker—Low Battery Drain.

Table Model—162T—\$62.95

Console Model—162C—\$82.95

Forge ahead with

1920

FADA

1936

Radio

o o Famous Since Broadcasting Began o o

FADA RADIO
AND ELECTRIC
COMPANY

LONG ISLAND
CITY
NEW YORK

RADIO RETAILING

RAY V. SUTLIFFE
Editor

W. W. MacDONALD
Managing Editor

T. H. PURINTON
Assistant Editor

HARRY PHILLIPS
Art Director

•
HOWARD EHRlich
Vice-President

H. W. MATEER
Manager

•
Tom Blackburn
Chicago

George Tenney
San Francisco

Leonard Church
Cleveland

H. S. Knowlton
Boston

Vol. 20

No. 12

CONTENTS, DECEMBER, 1935

Copyright, 1935, by McGraw-Hill Publishing Company, Inc.

<i>News and Views</i>	9
<i>Auto-Radio Statistics</i>	10
<i>Money on Trade Ins.</i>By W. W. MacDonald	12
<i>World Cruise Moves 122 Sets in Week</i>	14
<i>Sales Ideas</i>	15
<i>Sets Across the Sea</i>A Pictorial	19
<i>Department Store Methods</i> ...By H. L. M. Capron	20
<i>Things No Radio Can Do</i>By Edgar Felix	22
<i>While the City Sleeps</i>	24
<i>Christmas Records for Children</i> .By Richard Gilbert	27
<i>News of the Month</i>	30
<i>Broadcasting At a Crossroad</i>	32
<i>New Merchandise</i>	35
SERVICE SECTION	
<i>Circuits of the Month</i>	43
<i>Shop Shortcuts</i>	45
<i>6E5 As Service Tool</i>By Waller and Richards	47
<i>Tricks of the Trade</i>	53

FACTORS FOR OVERPRODUCTION

The "off-timed" introduction of metal tubes has created a series of factors which will bring about an overproduction situation this spring unless carefully watched.

Announced last April as a laboratory perfected invention, an unexpected demand from many set makers to make this device available for use in their receivers "at once," forced its hurried manufacture on a large production basis ahead of original plans.

Quite naturally, initial output could not keep pace with early season requirements. Result, back orders, duplicate dealer commitments and the consequent rapid expansion of manufacturing schedules.

December finds the set makers caught up on their distributor orders—and dealer cancellations in the offing. Past history in the radio industry has shown that such a situation has resulted in overproduction during the late winter and dumping in the spring.

While our conversations with parts and speaker executives indicate that factory schedules now total far and above the normal consumer demand for sets after the first of the year, interviews with the larger makers of receivers bring forth the reply that "the situation is well in hand."

We hope that the latter gentlemen are right—and that neither they nor the smaller concerns will find it necessary to resort to "special propositions" after the holiday season.

The Metal Tube that
the Industry hoped for...
IS HERE!

ARCTURUS
"CORONET"
the Perfected
METAL TUBE

UTILIZING all the advantages of manufacturing technique developed in the past 28 years, Arcturus has perfected and improved "the greatest advance in radio tube design in 28 years." The radio industry, aware of the inherent weaknesses of metal tubes, had looked forward to an improvement by 1936.

Now, a full business year ahead of the industry, Arcturus introduces the CORONET Metal Tube—the *perfected development of the metal tube*. CORONET Metal Tubes at once advance the metal tube development from an experimental stage to a dependable design using all the tried and proved advantages of the vacuum tube art.

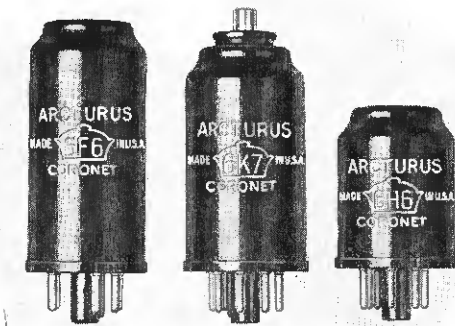

CORONET Metal Tubes incorporate
28 years of manufacturing technique

THE SALIENT FEATURES OF ARCTURUS
CORONET METAL TUBES ARE:

1. Lower capacities than either other metal or glass tubes.
2. More dependable vacuum than the original metal tube.
3. Less prone to gas than the original metal tube.
4. Lower operating temperatures permit closer arrangement of chassis components.
5. Eliminate possibility of dead shorts to ground.
6. Diameter identical to other metal tubes.
7. Height $\frac{1}{2}$ inch greater, facilitating insertion and removal.
8. Rugged structure; better appearance; longer life.
9. Quiet operation, as it has no metallic sleighbells.
10. Self shielding.

Get the details of this remarkable new improvement today.
ARCTURUS RADIO TUBE CO., NEWARK, N. J.

ARCTURUS
RADIO TUBES

ARCTURUS PIONEERED 6 OUT OF THE 7 FUNDAMENTAL DEVELOPMENTS IN A. C. TUBES
ARCTURUS NOW PIONEERS THE PERFECTED METAL TUBE

DECEMBER

1935

News and Views

CUT PRICES on metal tubes are featured in recent editions of the radio mail order catalogs, many of which find their way into the hands of the consumer. Current list prices averaged \$1.75. "Our price" is approximately \$1.03.

★ ★ ★

THE PHENOMENAL SUCCESS of two or three well established manufacturers of wind-powered generators has led to the inevitable. Other companies are rushing into this picture, some of them under-financed or without the necessary engineering background.

To produce a satisfactory wind charger is not as simple as it seems. An amazing amount of research, a thorough knowledge of aerodynamics are prime requisites to success in this new field.

We hope that this development will not receive a black eye from those ill-equipped opportunists who think they can pluck some "easy money" out of the air.

★ ★ ★

COMMON SENSE sticks out all over the following statement of tube type policy by a certain set maker whose product is renowned for its quality: "We prove, in our ZQ series, that we can make sets with six glass tubes that will be more sensitive, better in tone and easier to operate than other six-tube radios, and competitive in price, size, selectivity and appearance.

We prove in our YX series that we can duplicate set performance with seven metal tubes at less-than-average cost. And in our Models A and B that we can produce metal-tube sets giving the volume, tone and sensitivity expected of several more tubes and therefore the most economical metal-tube sets to operate.

"As to the future, this company will continue to choose the best tubes for each purpose according to our own tests and standards."

★ ★ ★

GIVE THEM THE WORKS!

This year, due to the clean-cut appearance of the underside of the radio chassis, dealers are featuring special display stands which permit the underside of the assembly to be readily viewed.

American Bosch, for example, capitalizes on the following points: "Ninety per cent less wiring, 104 soldered joints eliminated . . . means more stations, better tone, less noise, easier tuning and greater durability."

★ ★ ★

A NEW HIGH in Radio Showmanship was sprung Armistice Day. Dealers who didn't tune in on those breath-taking broadcasts from the stratosphere ship "Explorer," 14 miles up, to the "China Clipper," with London and with people all over the U.S.A., missed a first hand chance personally to proclaim the wonders of radio to their prospects.

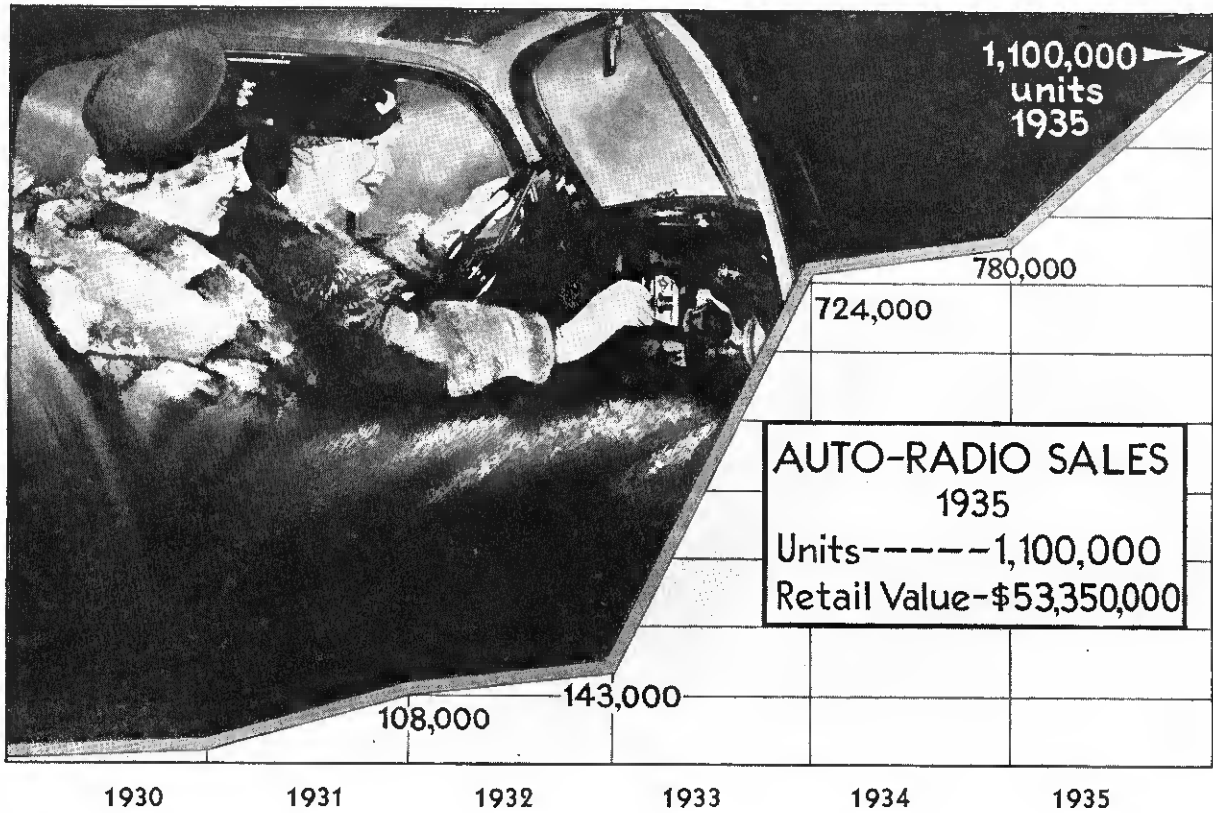

Auto-Radio Sales Top Million Mark

Average Retail Selling Price . . . \$48.50 Average Number Tubes . . . 5.8

Number of Radio-Equipped Cars in Use (approximate) 2,300,000

THE SALE of radio sets for automobiles, trucks and buses as well as for pleasure cars, again registers a spectacular new high. Jumping from 143,000 car receivers in '32 to 780,000 in '34, this year's figure will top the million mark. Retail billings are up 64 per cent—\$32,500,000 (including tubes) for 1934 to \$53,350,000 in 1935.

All above statistics were obtained by "Radio

Retailing" direct from the set makers, December sales estimated. Totals were rechecked with the parts and speaker suppliers.

Radio in the motor car has become an accepted accessory. Safety engineers favor its use as an aid to careful driving. Automobile manufacturers view with greater favor its value as a sales factor, providing, antenna and mounting facilities on most models.

GENERAL BUSINESS

Passenger car sales	37% above '34
Radio excise taxes (10 months, 1935, \$3,134,941)	Up 26% over '34
Household refrigerators	15% up from '34
Railway net income (Sept. and Oct.)	Highest since Oct., 1933
Steel shipments (U. S. Steel Corp.)	Double those of a year ago
Broadcast advertising (third quarter)	Gained 33.2%
Durable goods industries	Well on recovery road

News and Views

"STATIC ELIMINATORS" are available in certain cars put out by General Motors. This grounding device is located in the wheels of the automobile and functions the same as the trailing chain underneath gasoline trucks.

♦ ♦ ♦

ONE IN EIGHT is the ratio of new motor cars equipped by the auto dealer with radio, according to one of the more aggressive car manufacturers. He was referring to his own make of automobile. The national ratio, "calling all cars," would appear to be not more than one in ten.

♦ ♦ ♦

CONCEALED SPEAKERS, underneath the lining of the car's roof, were noted in a few of the 1936 automobiles. "It must be heard to be seen."

Radio is no longer a hit and miss installation affair in automobiles. It has been definitely allotted a prominent spot in the new cars—even though the speaker cannot always be seen.

♦ ♦ ♦

RADIO AT THE AUTO SHOW was as popular as ever. Space was provided on all the better cars for a set if desired. The tendency to let the dealer—automotive or radio—make the installation at point of sale still remains.

Two new kinds of antennas, when the roof is all-steel, were noted: Chrysler and others insulate a section of the roof itself. A condenser must be placed in series with the lead-in on these jobs. And the new Lincoln Zephyr's may be had with rear storage compartment door insulated—for those who want to try their luck with this steel plate as a signal catcher.

TUBE BATTLE still rages—with RCA telling readers of 100 newspapers throughout the land that "Metal tubes are the sign of an up-to-date radio." Some 50,000 reprints of these ads have been distributed by the 48 cooperating set makers, and special sections, with local tie-ups, are making their appearance in a number of towns. This campaign is scheduled to run until Christmas. Metal tube advocates are delighted. Other dealers inclined to discount the strength of some of the assertions in this copy.

♦ ♦ ♦

NRA WILL PASS into history within a few weeks, according to all indications in Washington, but a movement will start to organize the radio industry along industrial union lines as advocated by John L. Lewis, resigned vice-president of the American Federation of Labor.

♦ ♦ ♦

TUBE DEALS in which test instruments are offered as premiums are again springing up like mushrooms. We watch them spread with mixed feelings. For while it is true that in some instances such deals may have enabled servicemen and dealers to obtain equipment on a painless basis they sometimes give the trade the impression that it is being loaded up. And the business of test equipment makers unquestionably suffers.

♦ ♦ ♦

STATICLESS RECEPTION was demonstrated last month in New York City by Major Edwin H. Armstrong, professor of Electrical Engineering at Columbia University. Keen interest was expressed in this development.

Major Armstrong showed that through his system programs were received in Haddonfield, N. J., from transmission of the short-wave station atop the Empire State Building without any static even in a thunder-

storm. He demonstrated by means of recordings that reception of long-wave stations at the same time showed the static effects of the storm.

We would again point out that this method calls for an entirely different type of *both* transmitter and receiver than now in use. Therefore its commercial adoption is afar off.

♦ ♦ ♦

AN ORCHID to Bond Geddes of the Radio Manufacturers Association for his masterly opposition to the proposed St. Louis Board Bill No. 293 to prohibit automobile radio.

In a 21-page "brief" Mr. Geddes told the St. Louis city fathers why such legislation not only is unlawful and to the detriment of the local citizenry but also the ridiculous aspect of such a measure.

Anyone who wants a copy of this complete presentation of automobile radio as a safe versus an unsafe driving factor should write to the RMA, Washington, D. C.

As we go to press this bill is "in committee" with every prospect that it will be killed.

♦ ♦ ♦

FIFTY FIELD SUPERVISORS is some sales organization in any jobber's language. But they're now on the staff of Raymond Rosen & Co., Philadelphia. Directed by Russell Clarke, their job is to help the dealer hire and train specialty, door-to-door salesmen.

In a recent interview Mr. Clarke justifies this policy with this philosophy: "Radio has become a specialty business. . . . With the 'over \$100' prices now prevailing the margin is there. . . . Every dealer should not only operate an outside crew but should give his men other electrical appliances to sell at the same time. . . . The stage is set for a new kind of public radio buying. . . . We can prove to a dealer that, with higher prices, he has something like twice the amount of money to work with per sale, that his profits can be doubled, that his salesmen's commissions will be increased and his collection expense be lowered if he operates an outside crew."

Ray V. Sutcliffe

EDITOR

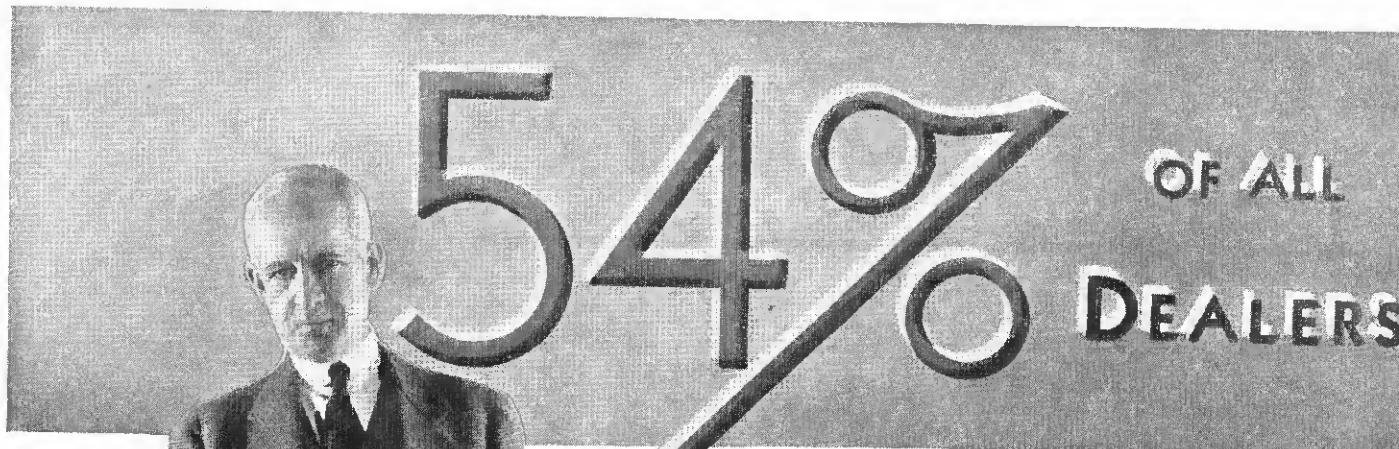

HORSE-TRADING called best solution for today's used set problem by 410 retailers contributing to *Radio Retailing* nationwide survey

By **W. MacDonald**

NOT so long ago flames licked greedily at huge pyres of used radios. Bonfires of traded-in sets, gathered by retail associations to clear the market for new merchandise, lighted the American scene, were liberally press-agented.

This was laudable sentiment. For nothing is quite so noble as the sacrifice of immediate profit for a far-sighted principle. But gone are those days. Economic pressure has forced the industry to dispose of used merchandise in a less philanthropic way. Re-sale of trade-ins may injure and undoubtedly does injure tomorrow's new set market. But baby must have new shoes . . . today.

Radio Retailing has just completed a national survey of retail trade-in practice. We found no ideal system. Nor did we find conditions particularly bad. The trade has apparently learned to handle a nasty situation without too much loss. And in some instances it has turned a necessary evil into a profitable activity.

If You Don't Trade You Don't Sell

Ninety-eight per cent of all dealers now accept trades. Competition forces them to. For a radio to just play is to fulfill a major part of its function. So we can't really blame the consumer for failing to believe his set absolutely worthless if it plays. It is worth something.

Trades are taken, it develops, on 61 per cent of all new set business. This checks closely with our recent statement that 70 per cent or more of the new business is replacement. Some buyers are obviously talked into keeping their old sets.

When it comes to deciding trade-in policy there appears to be four distinct schools of thought. Thirty per cent of all retail stores allow something on trades regardless of the price paid for the new receiver. Here competition . . . business at any price . . . rears its ugly head the highest. Fifty-five per cent claim that they will not touch a trade-in with a ten-foot pole where the new set goes under the hammer for less than \$39. But we strongly suspect that the wish is sometimes father to the thought. Another 8 per cent say frankly that they try to confine trades to console sales, but that they can be "had." And the remaining 7 per cent accept used stuff only when it can be re-sold at a profit, a hard-boiled policy, but a rapidly growing one.

Here you have the industry's current trade-in practice in a nutshell. It is apparent that while a large majority of dealers lean over backward to satisfy the man who insists on his pound of flesh more than half of them at least make some effort to stop it from running wild.

One needs more intensive training in the Black Arts

Make Money on Trade-ins

than we profess to determine how the trade arrives at its maximum allowance figures. Thirty-nine per cent of all dealers surveyed simply keep a weather-eye on the new sales' gross-margin and balk when the customer begins to draw blood. The average maximum allowed by this particular group is \$22.

The remaining 61 per cent "horse-trade" until it appears certain that the transaction will be profitable and have no established maximum allowance. This seems like a sensible procedure to us.

That the trade-in situation is not nearly so sour as it was just a few short years ago seems evident, as 54 per cent of our correspondents now maintain that they make a profit on the re-sale of trade-ins. We think it probable that this statement would be more accurate if the word "gross" was inserted before the word "profit."

This particular group, to our thinking, probably makes a small net on its used set turnover, but not as much as it thinks it does.

The remaining 46 per cent of the trade states in so many words that it loses money on trades or, at best,

breaks even. Many of these dealers obviously do not consider a means of profitable disposal until the customer is on his way out with the new merchandise. Some operate under mental hazard, *expect* to lose money on trades and therefore naturally do.

Disposal Is the Key to the City

As we pointed out just before plunging into the maelstrom of figures, trade-ins are just dropped on our doorstep and there's nothing to do but open the door and take the little brats in out of the snow. Equally as important as the amount of hard-earned cash we spend on them is the means of shipping them as quickly and painlessly as possible to the nearest asylum.

Sixty-one per cent of all dealers who accept trade-ins re-sell everything they take in trade. This is a figure much higher than we would have guessed and indicates that these dealers do not take in sets that are completely beyond the pale. Another 36 per cent re-sell some of their used sets, break up others for parts and get rid of

(Please turn to page 38)

NEW FACTS ABOUT TRADE-INS

98% of all radio dealers now accept trade-ins

61% of all new set sales involve trade-ins

55% of all dealers limit trades to sets over \$39

35% take trades irrespective of the new set list

8% confine trades to consoles

7% accept trades only when they can be re-sold at a profit

54% claim they make a profit on trade-ins

46% say they lose money, or break even

61% re-sell all trades themselves

36% re-sell some, break up some, junk some

3% throw them away, or donate to institutions

80% of the dealers who re-sell, re-condition first



Crowds like this were attracted by this Saturday broadcast direct from the window

“World Cruise” Moves 122 Sets in Week

Novel Weeks & Dickinson promotion idea turns window-shoppers into buyers

BINGHAMTON, N. Y.—The private radio show has been plugged so often that despite a certain appeal at the opening of each new season it now falls flat unless the dealer injects new promotional ideas of his own. Weeks & Dickinson, music and radio house, noted for its originality, injected the needed note of novelty into a recent show, labelling it a “World Cruise” Show. In one week, as a direct result, the store moved 122 radios, 110 of them new models averaging \$65, the remaining 12 trade-ins.

For 9 years this house has taken radio time daily over a local station, broadcasting from its show window on Saturdays. So popular has this air offering become that a survey puts it in 6th place for local popularity despite competition with chain programs. One of the regular Saturday window broadcasts opened the week and two of the pictures reproduced show the crowd attracted and the broadcast itself in actual progress. Mr. Weeks, well known in trade circles, is at the left in the broadcast window.

Immediately after the broadcast a crepe paper and cardboard ship labelled “SS W-D” was installed in the window together with signs inviting the public to come in and “cruise around” among the season’s new radios without obligation. And when they did enter the informal cruise atmosphere was perfectly continued by conversion of one whole section of the store into a ship of gigantic proportions, complete right down to the cabins.

The ship itself was formed of crepe paper over old shipping cartons. But the

cleverness of the display is particularly noticed in the labelling of the various cabins. There was an RCA-Victor cabin, a Zenith cabin, a Grunow cabin and a Philco cabin, each set aside as a place where the world-cruiser might step inside and listen to a demonstration of the set of his choice. Further carrying out the idea, there were cabins for “Commodore” Edwin R. Weeks and “Admiral” C. H. Dickinson, who did much of the selling. Also a cabin for “Captain” Darch, who did most of the closing. And another cabin for “Purser” Mason R. Lowell, the credit manager.

The entire personnel of the store was dressed as ships’ officers and crew and a “stewardess” gave away 2,500 roses to guests, another attraction which pulled people inside to the demonstration display. Preceded by a three page newspaper announcement and the window broadcast it was inevitable that such a novel window and store display should attract, especially in a town of Binghamton’s size, where novelty is rare.

The entire expense of the week of promotion was less than \$400, which included decoration, costumes and newspaper and radio advertising. This, says Giles H. Dickinson, vice-president and treasurer of the company, is not excessive when it is known that sales are continuing at the highest point since the start of the depression in both the radio and musical instrument departments.

Radio Hospital Checks Ad Results

Finds clever phone book copy produces 70 per cent of business

ALLENTOWN, PENNA.—Jack Muthart of the Radio Hospital, cautious about the way he spends his advertising dollar, has gone out of his way for the past 10 months to determine what type of promotion brings the best return. All new customers have been asked how they found him, the answers tabulated. The result indicates that fully 70 per cent were unearthed by telephone book advertising.

Perhaps this is because Muthart’s telephone book copy is particularly effective. “Not all people are educated to use the classified directory,” he advises. “But the first thing many do is look under R-for-radio in the regular book. So at the top of the page in bold-face type I carry an ad playing up the words *Radio Hospital*, listing the phone number and address.”

Muthart experiments with promo-

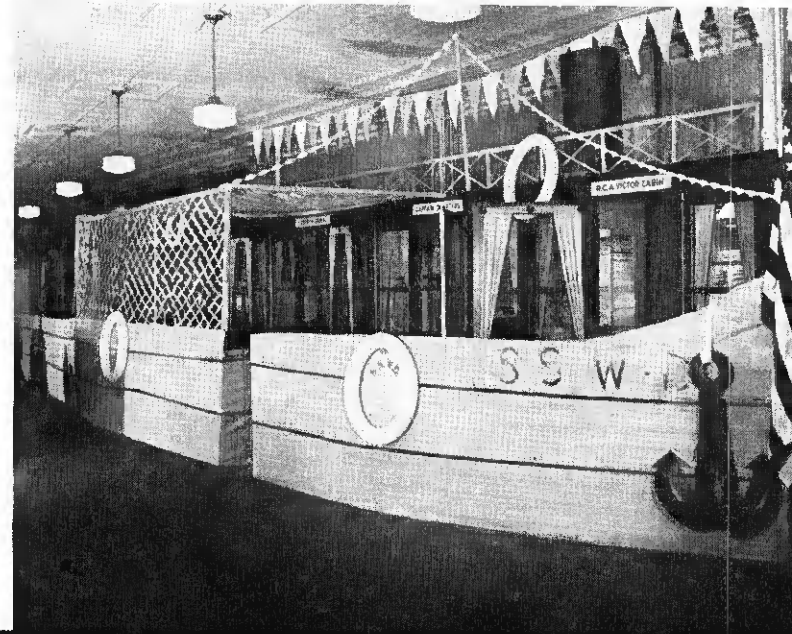
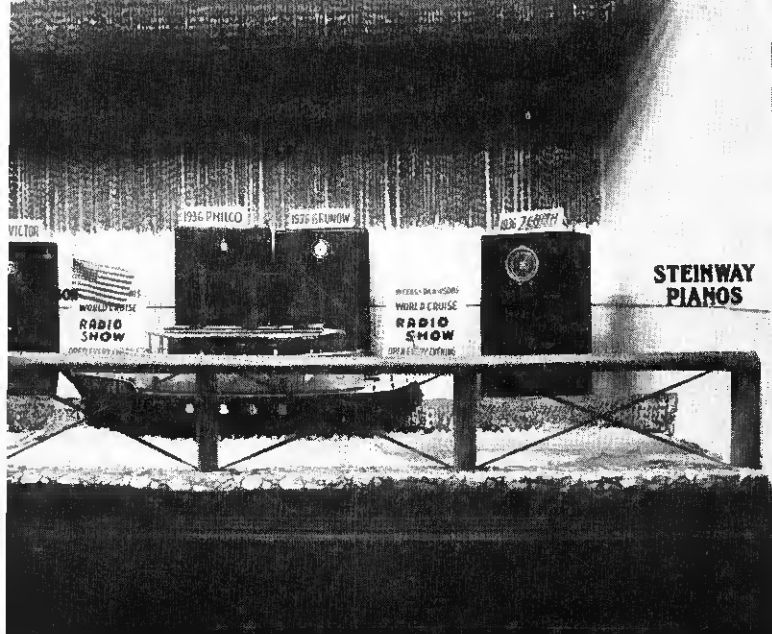

And during the week this display invited people inside where the "World Cruise" Show idea was cleverly continued

tional ideas, thinking them up in spare time, trying them when business seems slack. Some turn out well, others fall disappointingly short of expectations.

"I put out 6,000 three-by-five cards with a little blue border, bearing the illustrated title: 'A Seven League Boot Service.' It was in postcard form and could be either mailed with a one-cent

stamp or distributed by hand. We tried both systems of distribution and they seemed to pull about the same. Hand distribution was cheaper, however.

Novelties are good advertising only when particularly attractive ones that do not cost too much can be found, many servicemen report. Muthart's experience bears out this statement. "The

best thing I ever used was a small imitation radio cabinet with a roll of paper inside which could be pulled out and used as a telephone number index. It bore my name and address in the "R" section. This novelty pulled very well but it cost me 21c. and it was necessary to distribute it only to people who were fairly certain sources of repeat business."

Simple Card Keeps Service Records

Method used by V. W. Hodge is cheap, efficient

CLAREMONT, N. H.—The following method of keeping service records at low cost is recommended by V. W. Hodge of Radio Repair Service:

"Get a bunch of cards as per sample. Regular index cards will do. Or your local print shop will cut out a thousand for a few cents. Number every chassis, speaker, powerpack or other unit that comes into the shop. Put this number on with a special 'grease' pencil used to mark glass or crockery (see your stationer), made of soft, black wax.

"After you have completed repairs fill out an index card for the job and put down the job number, together with all the data as to parts installed, name of customer, charge made and any other facts about the transaction that may be useful later on. These cards are not meant to be a bookkeeping system but just a record. File them numerically, by job number.

"Now, if in the course of a year a job is brought back it is a simple matter to locate its card by the number and the information noted will often simplify the work and permit you to turn out a better repair. A small paper tab

stuck to the edge of the card the second time a job comes in will quickly identify 'repeaters.'

"I find my cards extremely useful, also, when conducting direct-mail sales campaigns. By glancing at the model and make of set in each case I can quote the exact price of a replacement set of

tubes. I also capitalize on the index by advertising that I keep a complete job record.

"Indexing is absolutely necessary if the serviceman is to make the most of each customer's business. And customers are too few and far between to do otherwise. Good indexing of jobs also speeds up shop routine. Most men in the business appreciate the value of records but many do without them, nevertheless. Obviously the reason is because systems heretofore suggested have seemed more difficult to keep up than was warranted."

A-866	Philco 16
July 1, 1935	
John Jones 16 Main St.	remove and clean volume control check tubes
	Will need tubes in Fall
	\$3.00

Hodge's record card. The job number is at the upper left, set identification at the upper right. Note the "tickle" reference to a possible tube sale in the lower right.

Collects 50% Of Charged-Off Accounts

C. B. Kaufman tells how he keeps credit losses below 1 per cent

LOS ANGELES—"No dealer can afford to let bad accounts go entirely even after he has charged them off. We bring in fully 50 per cent of our charge-offs every year simply by continuing to follow up the people by mail and in person even after recovery seems unlikely." So says C. B. Kaufman, owner of the Qualitone Radio Company, who holds losses to less than 1 per cent despite the fact that he is considered extremely liberal in extending credit. Believing that well-rated people often don't pay and that poorly-rated ones frequently are the best credit risks, this dealer grants credit largely on character reference.

At the end of each year, Kaufman charges off absolutely every account that is the least bit questionable. The same applies to merchandise. In this way, stock and accounts are both kept in liquid condition, the store doesn't kid itself about assets. When bad accounts are collected they have been figured out of the operation and whatever is recovered is pure gravy.

Tracer letters are the principal follow-up medium. When ordinary statements and letters fail to bring collection results two men are sent out to get the

payment or the merchandise. If the customer has "skipped" . . . which is where most losses occur . . . he is sent a registered letter with a request to the post office department for a forwarding address. An ordinary statement or

piece of sales literature is inclosed, just anything which can be delivered as a letter. The entire purpose is to locate the customer so that he may be contacted personally.

When a skip is located a free-lance collector who devotes his time to the accounts of several companies is sent out to get the money or the merchandise. On all accounts of this kind he is given 50 per cent of what he collects.

"This system has contributed greatly to the present healthy state of my business," says Kaufman. "It permits us to make the most of old stock and overdue accounts without counting on them too much when figuring assets."

★

Real Car On Radio Floor Boosts Auto-Radio Interest

Platt Music junks trick display boards for more realistic display

LOS ANGELES—Car radio sales showed marked improvement when Platt Music of 718 South Hill rolled a real automobile through double-doors right onto the radio showroom floor and installed a set therein.

A sign outside the store announced: "You may hear an auto-radio in an automobile before you buy." This idea seems to appeal to prospects. In addition, the

car itself, plainly visible from outside through the glass constitutes a dramatic display far more effective than the trick mounting boards hitherto used.

The car was borrowed from a local dealer at no cost. A placard on the front bumper gives the "loanee" credit and has resulted in several automobile sales. A salesman is always stationed near it to develop leads.

★

Outside Displays Pull Business

Filling station and movie palace cooperate with Tosa Radio

WAUWATOSA, WIS.—B. and H. Koseja, owners of Tosa Radio Service, swear by outside displays and demonstrations as a means of pulling in extra radio business. "Store traffic is rarely heavy enough in this business," they state, "hence every means of getting your merchandise before the public outside the store helps volume."

A nearby filling station cooperates by permitting the display of an auto-radio in its small window. And inside the station a midget home model is connected and running. It serves the double purpose of amusing the station attendants through the long winter evenings and demonstrating itself to prospects who wait inside to keep warm while their cars are given the once-over. "We

have had more inquiries about the midget, curiously enough," say the Kosejas, "than about the car set."

A commission is paid the station on completed sales. So many people are in and out of the place daily that results are certain to be good.

A local movie house has another Tosa set, this time a console, installed in its lobby. Each evening the set is played for half an hour, without any mention of Tosa Radio. But at the conclusion of the program the fact that the store loaned the set is flashed on the screen along with other advertising announcements. Here again the theater receives a small commission on leads which eventually result in sales.

Photos at right show the installations.



OUR SETS MUST BE SUPERIOR!

Why don't we change to Aladdin Polyiron Core Coils?



"On the Carpet"

Pres.—"We need a more competitive set—a radio that sells itself on performance. If Polyiron coils are what we need, let's use them!"

Eng.—"We've been running some tests on Aladdin Polyiron Coils—they're cathode-ray tested in production and are all that is claimed for them. I'll have a complete report ready this afternoon, sir."

Pres.—"Fine, build up a couple of sample receivers and let me know how soon we can get production. We've got to have a better set on the market, and have it quick, before our competition wakes up to the value of Aladdin coils."



Aladdin
L. O. W. A. S. E.

Type C Compact Polyiron Core I. f. Transformer

A logical companion for metal tubes in mobile and home receivers. Strengthen your sales with a finer receiver that has greater sensitivity, high gain, optional high fidelity, and better all-around performance. The best radios sell! Superior performance is your best assurance of increased sales.

Aladdin Radio Industries, Inc.
Licencees of Johnson Laboratories, Inc.
466 West Superior Street Chicago, Ill.

Memo: *Engineering Dept.*
to

Use Aladdin Polyiron core coils for all new models — Better Selectivity — Greater Gain — High Fidelity, and Smaller Size.

Murray
PRESIDENT

Aladdin Polyiron Core Coils make superior radio receivers

The Sensational
Belmont Model 770
Uses Aladdin Polyiron Coils

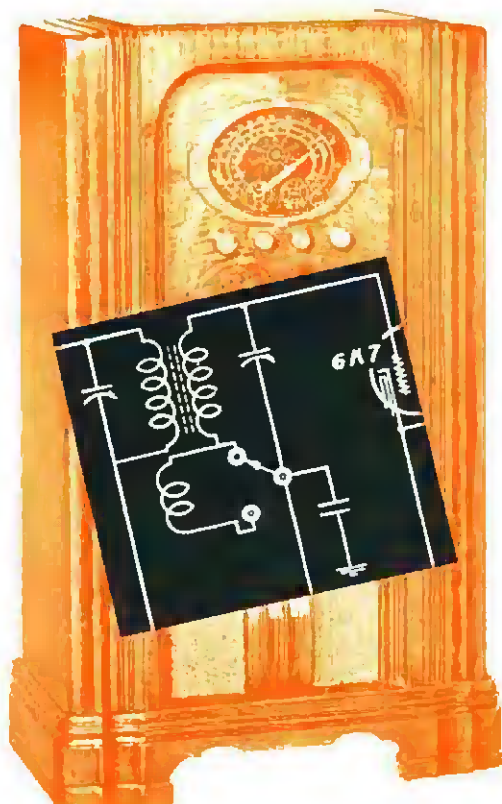

High fidelity! Band-expansion! Gain! Sharp cut-off! Belmont engineers utilize the advantages of Aladdin Polyiron in the design of their I.F. converter transformer with an auxiliary winding close to the primary to secure extra band width through overcoupling. The high Q factor of Aladdin Polyiron core coils assures a sharp cut-off at 10 or 20 Kc. with ample gain.

Polyiron is a patented magnetic core material molded from microscopic insulated particles of iron. The character of this material differs from ordinary iron in that eddy currents and hysteresis losses which occur in solid iron at high frequencies are not present in the Polyiron.

The effect of this magnetic material in the core of an I.F. coil is to reduce the amount of wire necessary to secure a given inductance and to concentrate the magnetic field. This results in a high Q ratio of inductance to resistance and lower distributed capacity, due to less wire being used. Thus, the resonant peak of a Polyiron core coil tuned with a well-insulated condenser becomes very much greater than is possible with an air core coil. This means that the gain increases as well as the selectivity. For certain applications coils may be arranged in an optional high fidelity circuit manually controlled to pass a desired band of I.F. signals without appreciable loss of gain. Coupling of the coils may be varied in manufacture to secure flat-topping, sharp peaks, or maximum gain without sacrificing any of the advantages of high Q or the wide tuning range of the midget trimmers.

A typical example of the flexibility in design made possible by the use of Polyiron is illustrated in the band-expansion curves of the type H-103 Aladdin I.F. converter transformer.

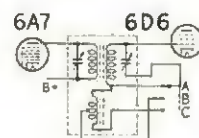
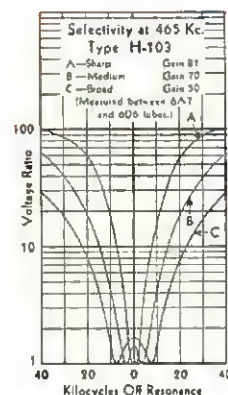

Band-expansion I.F. type H-103 Aladdin Polyiron core transformer provides an intermediate high fidelity step to reduce heterodyning from adjacent frequency channels.



Improved sensitivity and sharper tuning make Aladdin Polyiron core antenna and R.F. transformers your first choice for the finest auto and home radio receiver designs.



Radio Industries, Inc.
Licencees of the Johnson Laboratories, Inc.

466 W. Superior Street Chicago, Ill.
Phone: Sup. 5644 Cable address: Aladdin
333 E. 43rd Street, New York, N. Y., Phone:
Murray Hill 4-2837.

These devices are manufactured under one or more of the following patents. 1887380, 1978599, 1982690, 1940228, 1978600, 1997453, 1978568, 1982689, 2005203, 2002500, 2018626. Other Patents pending.

SETS ACROSS the SEA

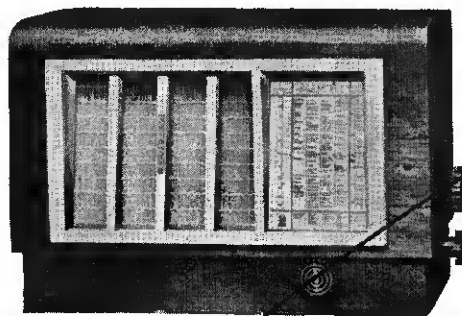

TIME-TABLE DIAL . . .
A popular style from the Reich

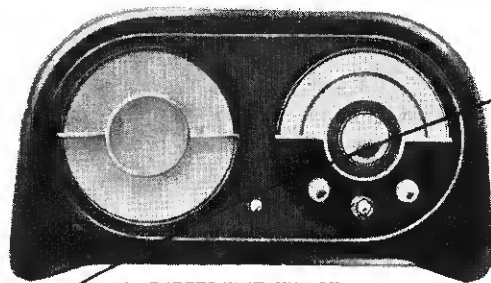

A DIFFERENT TWIST . . .
Another British innovation

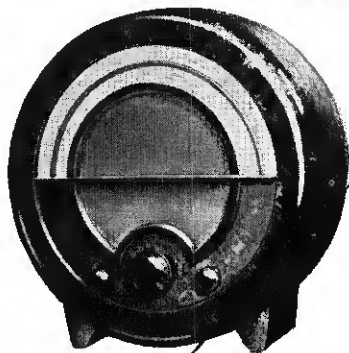

ROUND, AND WHY NOT? . . .
Largest tuning dial in England

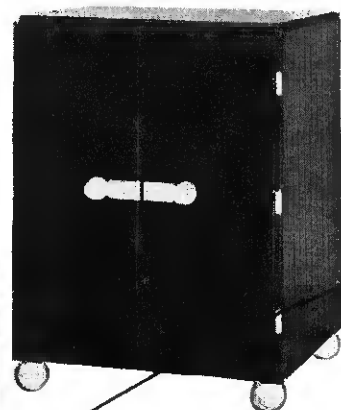

MAN IN EVENING DRESS . . .
Table model so nicknamed by Berlin-ers



ALL DONE WITH MIRRORS . . . And France has a good excuse



NEW SLANT ON LEGS . . .
It fits the London taste

Selected out of the new foreign crop for originality of cabinet design, these receivers may give American stylists ideas

NOT A PIANO
A novelty, even for Paris

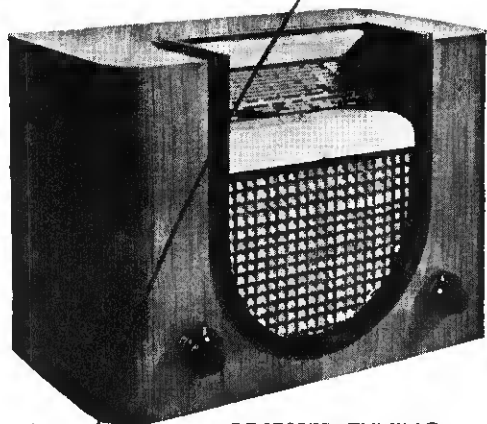

RECESSED TUNING . . .
As the Germans see it



Big... Shrewd... *and*

3 TYPES OF DEPARTMENT STORE OPERATIONS

At the present time department stores elect to merchandise radio three different ways, "Radio Retailing's" November survey reveals:

1. Standard Lines—Standard Prices

Older, conservative establishments carry nationally known lines and generally abide by the manufacturers' suggested selling prices.

Examples: Wanamaker, New York and Philadelphia (has enjoyed a steady volume, without material increase, for 10 years); The May Company, Cleveland (runs separate basement department for discontinued models and midgets); Marshall Field, Chicago; Bullocks and Robinsons, Los Angeles (maintains list prices, caters to "charge account" trade); R. H. White Co., Boston (buy for cash, "cooperate 100 per cent with Better Business Bureau.")

2. Must Keep Competitive

The majority of department stores fall in this category, per accompanying article.

Examples: R. H. Macy, New York (has been very successful with its own brand of receivers; of recent years has also pushed well known makes at "6 per cent less"—and lower if competition necessitates).

3. Features Bargains

This group of large merchandisers is shrinking and finding it harder to make a profit due to scarcity of close-outs and public demand for standard quality merchandise.

Examples: Gimbel Bros., New York and Philadelphia (in 1924 one of the largest retail radio outlets in the country; now doing much smaller volume); Hearns' and Bloomingdale's, New York; Fair Store, Chicago.

MOST department stores have been building their reputations for over 40 years. They exert great influence in a community and they have good reputations. But they pay the price of leadership and of size.

Reputations cannot be made by selling poor quality merchandise or charging prices greater than actual value or in misleading advertising. These practices are conspicuous by their absence among department stores.

In the early 20's, radio prices were placed as high as possible and bore little relation to production and distribution costs. Most department stores, in an earnest endeavor to protect their customers from these too high prices, and from the sudden value shrinkages as the result of factory close-outs, elected to concentrate on their own brands. Private brands could be sold at much lower prices, the values were much more stable, and department stores could be protected from the ill-will and dissatisfaction which always results from too rapid depreciation of the value of their customer's purchase. Remember that department store customers may buy a hundred times as much other merchandise as radio.

Some department stores elected to sell only the "close-outs" of national manufacturers, to use these drastically reduced prices as advertising leaders.

One large New York store which followed this practice, built up a business of nearly three million dollars in

1924. How much profit resulted no one knows, but it had the largest retail radio sales volume in the world. Two years ago it woke up to find that its annual radio sales were then *less than a single week's sales in 1924*. An exception, of course, but still part of the picture.

I know of another store which for ten years never ran a sale of obsolete or distress models, concentrated on its own private brands, and in 1934 held 74 per cent of its 1928 sales. That, too, is an exception, cited to show that between these two extremes the majority of department stores have now found their present day, stable policies.

Enter, the National Lines

National manufacturers, eagerly trying to establish their own reputations, were fully aware of the favorable reputations of the department stores. They sought a means of turning these influences to the advantage of radio in general and themselves in particular.

To get their lines in, national manufacturers offered longer discounts, 40/10, 40/10/5, 50 per cent and even 50/10 per cent. They were always willing to pay 50 per cent of the cost of advertising the names together and very frequently would pay the entire cost. Such discounts are economically justifiable. It costs no more for a distributor to service a \$50,000 account than a

(Please turn to page 40)

Vulnerable

*Analysis of
Department Store Methods
Reveals Logic of Their
Radio Policies—
Alert Small Dealer
Need Not Fear
This Competition*

By H. L. M. CAPRON

*For 10 Years Radio Department Manager
for R. H. Macy & Co., New York City*

GALLOWAY



HIGH RENT locations increase department store overhead. The cost of running a radio department in a mart such as this (Macy's, 34th Street and Broadway, New York) averages 40 per cent.

Floor traffic is the department store's chief asset. Customer goodwill must be maintained. The necessity of rendering radio service regardless of cost, to hold the business of other departments, is a "soft spot."

IF two stations are on the same frequency and both are strong enough to be received . . . no set can separate them

IF there is "selective" fading . . . there will be distortion regardless of receiver used

IF a station fades badly . . . noise will rise and fall, even though automatic volume control keeps the level up

IF electrical noise at the antenna is as strong as the signal . . . no radio can eliminate it

IF a signal is weaker than local noise . . . no receiver can cut out the noise entirely and bring in only the program

No

TO ANTICIPATE, and so avoid, reception complaints the radio dealer should inform each set purchaser as to the stations affording the most reliable service in his respective area. This requires that the dealer himself be fully acquainted with the available service—and very few, judged by personal observation, are.

In the November issue of *Radio Retailing* I presented a chart from which salesmen may estimate the reliable service area of stations, based on power, frequency, terrain and distance. In this concluding article I shall further explain transmission phenomena in a manner which will permit the dealer to pass this information along to his customers and so remove from his shoulders complaints about reception which are no fault of the sets he sells.

No Set Can Separate All Stations

The allocation plan adopted by the Federal Radio Commission, predecessor of the present Federal Communications Commission, was evolved primarily with a view to accommodating all of the stations operating in the broadcast band at the time Congress authorized the commission to regulate allocations. Despite the generally accepted view that the number of stations would be greatly reduced at the outset the first re-allocation deleted practically no stations. With this fundamental handicap, coupled with the necessity of providing clear channels free of more than one night assignment, the allocation of channels other than those designated as clear has been generally crowded.

Only a few regional channels serve much beyond 15 to 25 miles at night (there are exceptions, such as 940 and 590 kilocycles in all parts of the country and a number of additional regional services in the Far West), while local channels are generally allocated so as to be of little use more than 10 or 12 miles from the transmitter. Furthermore, discontent with such stringent restrictions on service has encouraged extensive encroachments on the supposedly inviolate cleared channels with carrier synchronization expedients and directive pro-

posals of a nature which preclude the possibility of nationwide service on any one channel.

The simultaneous reception of two signals on the same frequency cannot be combated by any form of receiver selectivity. Listeners residing sufficiently close to regional stations to secure fair-to-good daytime reception are often mystified by the presence of flutter or whistle at night, particularly if they are in the critical area where the nearer station substantially dominates the signal from the distant station. Under these conditions, the nearby station's programs are marred, although the distant station causing the trouble cannot be readily identified. At locations closer to the regional transmitter, its programs overwhelm the distant station and it therefore offers clear reception. On the other hand, substantially further from the nearby regional, the distant station is identifiable from time to time, with the result that the listener eventually understands the cause of his marred reception.

It is not unusual, particularly in rural areas, that the receiver is demonstrated to the purchaser at a site where good service is rendered yet, at his home, a few miles farther from the regional, reception may be subject to occasional flutter. This is a type of complaint which the dealer must handle at the time of demonstration. He should determine where his prospect lives. If the location is one where flutter interference is a likelihood, the prospect should be informed of the possibility. At the same time, the dealer should tune in another station and suggest its use in preference to the first because it is interference-free at the listener's home.

Today's AVC Can't Correct "Selective" Fading

Another very frequent source of complaint is the fading clear channel station which gives good day service, but suffers from excessive fading at night. While it is true that automatic volume control maintains an even volume, the present type of avc is of no avail in combatting "selective" fading—that is, the fading of one part of the audio band while the balance remains stable. This produces distortion regardless of the volume stability gained through the operation of the avc.

There are Things Radio Can Do

*Much Depends on the Frequency Assignments,
Distance of Broadcast Stations and the Sooner
the Customer is Told So the Better*

says Edgar H. Felix

The intense fading area lies generally at from 80 to 120 miles radius from the transmitter and for a belt of about equal width. A higher frequency station of average efficiency is generally fading violently at 80 miles and may continue to do so for another 80 miles. At greater distances, the fading progressively becomes less severe until it is a relatively slow drift, quite readily controlled by the automatic volume control.

The most efficient long wave clear channel station with modern vertical radiator may not begin to fade with great severity until 120 to 130 miles from the transmitter. I have frequently recorded intense fading which involves change from minimum to maximum and reverse every few seconds, sometimes as frequently as twenty times per minute. At 400 to 500 miles, on the other hand, distant stations of high power and efficiency may hold for four to eight minutes without substantial drop in level or quality and restore to quality after only a momentary breakdown to the noise level.

Such stations should be known by the dealer and the purchaser should be casually but definitely informed of their existence.

Loudest Stations Not Always Steadiest

One notable fact, which contributes more to the tendency to rely on station in the severe fading range, is the fact that stations generally attain much higher levels on their peaks in their intense fading areas than do the steadier distant stations. Many uninformed listeners therefore assume that the loudest station is the best although (unless it is a nearby local) such a station is usually subject to the most troublesome fading and distortion.

The uninitiated listener needs help in choosing the best of service. Where local services are not sufficiently diversified to fully satisfy, the dealer should be prepared to recommend the best distant station for obtaining the steadiest and best reception of each of the four leading networks. For example, in central Pennsylvania, reliance upon Philadelphia or Pittsburgh stations at night is natural and logical, but far less satisfactory than the

lower level distant stations in Chicago, Cincinnati, Cleveland, Louisville, Nashville and Charlotte—all steadier than the Philadelphia and Pittsburgh stations subject, as they are at such distances, to intense fading.

Fading is sometimes experienced quite near to the transmitter, even in the case of high power cleared channel stations. This is true in areas subject to high attenuation, such as metropolitan cities and mountainous regions. In New York, for example, the signal from a 50-kw. transmitter may fade only 35 miles from the transmitter in directions where it must traverse the skyscraper areas. The intense fading area is that area in which the ground wave (comprising the signal radiated along the ground which constitutes the entire daylight signal) and the reflected sky wave at night are in about the same order of magnitude. Hence, if unusually high attenuation is experienced, the ratio is attained somewhat nearer the transmitter than the usual distance of 80 miles or more.

Occasionally poor quality is experienced in areas having very high buildings or precipitate declivities due to reception of a multiple signal reflected from such ob-

(Please turn to page 39)

TO AVOID RECEPTION COMPLAINTS—

Tell every new set buyer what stations give good service in daytime

Check off those that are unreliable at night and explain why

Indicate the best sources of chain broadcasts after dark

Explain why programs from stations 250 to 400 miles away often fade less than those originating between 80 and 150 miles distant

While the City SLEEPS!

**ALERT GE SALESMEN SELL \$300,000
WORTH OF ELECTRICAL APPLIANCES**

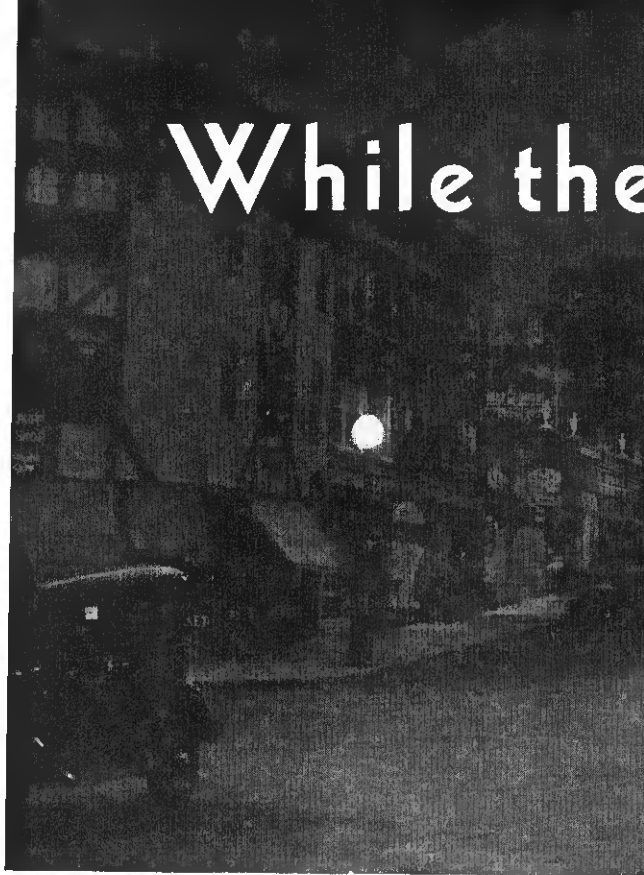

GALLOWAY

"Zim's Red Letter Day" demonstrates buying power of night workers—An untouched field for refrigerator dealers



THE CLOCK STRIKES TWELVE

But A. F. Head and his gang, instead of running home to sit by the fire, stick with the party. Electrical Household, Inc., Cleveland distributor for GE, recorded a total of \$46,000 in consumer business from nine a.m. till the milkman called the next morning



HE GETS A MILLION DOLLAR TRIBUTE

P. B. Zimmerman, recently promoted to head all appliance sales for GE, inspired this 24-hour campaign

CLEVELAND—Proving that America is ready and willing to buy, salesmen for General Electric home appliances staged a 24-hour nation-wide sales drive—running all through the night—and netted a total of \$1,365,227 in retail sales of electric refrigerators, ranges and dishwashers. Over 22 per cent of this, \$300,000, came as the result of after-midnight contacts.

The around-the-clock selling effort was a spontaneous tribute to P. B. Zimmerman, manager of General Electric's specialty appliance department. The day, November 1, was known as "Zim's Red-Letter Day."

Salesmen throughout the country, after calling on prospects at their places of business and in their homes, turned their sales guns on night workers. They sold the policeman on the beat, firemen, theatre attendants, motormen, conductors, railroad workers, bakers, telephone employees, morning newspapermen, restaurants, dance hall people and gas station attendants. In fact, they covered the

entire field of people who work through the night. After midnight they traveled in pairs.

Directing the one-day drive was Jean DeJen, national campaign manager, who established headquarters in the Hotel Statler for the day. Here hourly reports were received from General Electric distributors in 56 of the country's leading cities. As these reports came in by telegraph and over long distance phone, the hourly progress of the day's selling was chalked up on huge blackboards. An optimistic total of a half million dollars in sales had been set up as the day's quota. Officials had little hope of reaching it. But when the final figures had been compiled the sales had almost tripled that mark.

The results are all the more sensational when it is considered that the salesmen were in the midst of an eight-weeks' sales drive and that half of the distributors were over 100 per cent of their campaign quotas. Still, in the face

(Please turn to page 38)



1935-FRIGIDAIRE'S MOST SUCCESSFUL YEAR

A GREAT ACHIEVEMENT THAT SERVES
NOTICE OF THE OUTSTANDING
SUCCESSSES THAT ARE TO FOLLOW



IN 1935 more household Frigidaires were sold than ever before in a single year! . . . This spectacular accomplishment means a great deal—to you and to us. It proves that Frigidaire is more than ever the leader. It shows that we have the public's endorsement . . . that they believe in us. . . . But, what is of greatest importance is the fact that out of this tremendous success comes the experience for the most convincing, the most dramatic sales story ever told. From these outstanding successes we have discovered a new way to sell. It's the smoothest, fastest, straightest road to greater sales volume ever developed. Yes, we've learned a lot from 1935—and we've got the range for '36. Frigidaire Corporation, Dayton, Ohio.

You'll do better with Frigidaire in 1936!

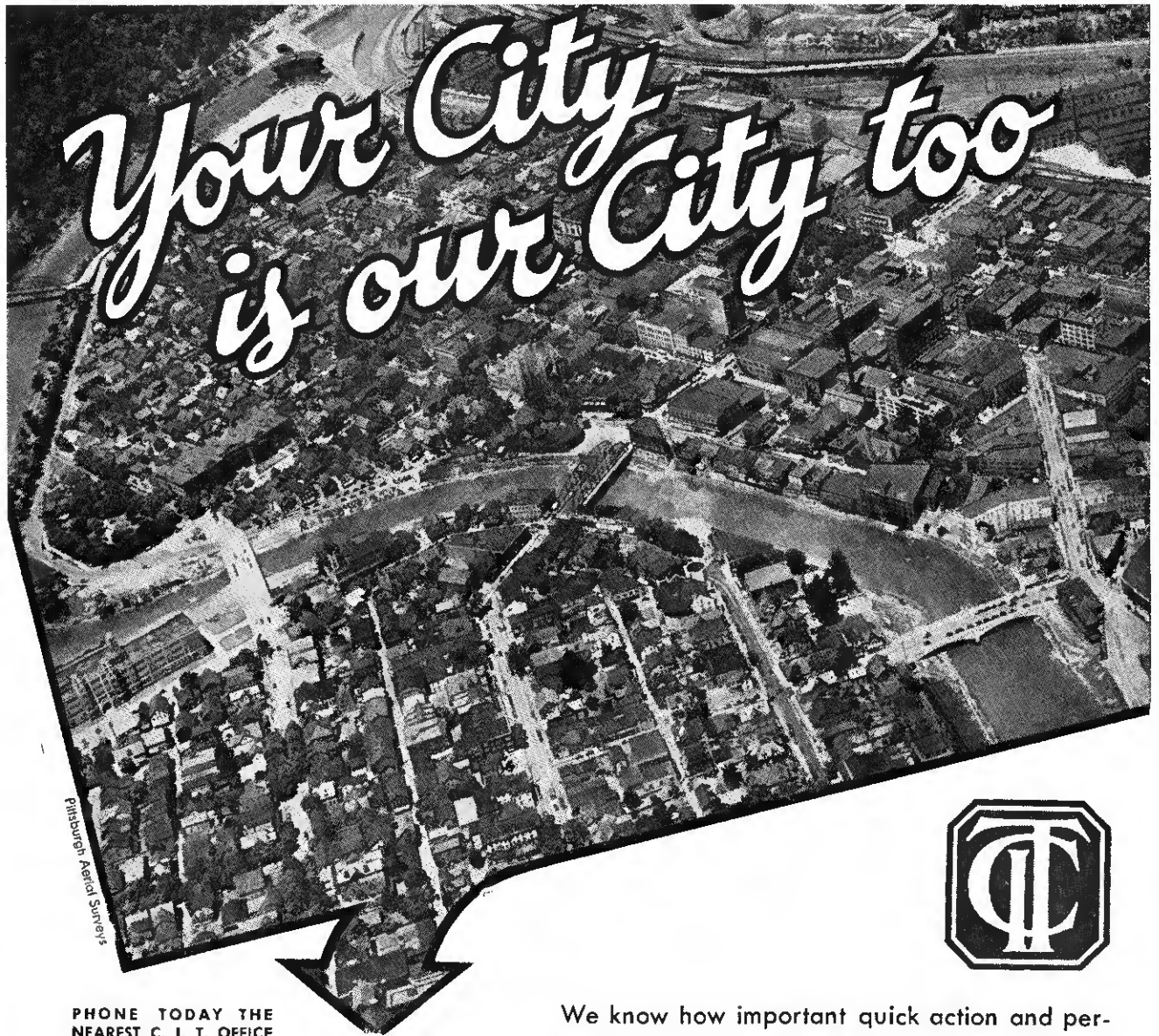

**PHONE TODAY THE
NEAREST C. I. T. OFFICE**

Abilene - Akron - Albany - Altoona - Amarillo
Asheville - Atlanta - Augusta - Bakersfield
Baltimore - Bangor - Bay Shore - Beaumont - Beckley
Binghamton - Birmingham - Boise - Boston - Bridgeport
Bronx - Brooklyn - Buffalo - Butte - Camden - Cape
Girardeau - Cedar Rapids - Charleston - Charlotte
Chattanooga - Chicago - Cincinnati - Clarksburg
Cleveland - Columbia - Columbus - Cumberland
Dallas - Dayton - Denver - Des Moines - Detroit
El Paso - Erie - Evansville - Florence - Fort Wayne
Fort Worth - Fresno - Glens Falls - Greensboro
Greenville - Hagerstown - Harrisburg - Hartford
Hempstead - Hickory - Houston - Huntington, W. Va.
Indianapolis - Jacksonville - Jamaica - Jamestown
Jersey City - Johnson City - Kansas City - Knoxville
Lexington - Lincoln - Little Rock - Los Angeles
Louisville - Manchester - Memphis - Miami - Milwaukee
Minneapolis - Mobile - Montgomery - Montpelier
Mt. Vernon - Nashville - Newark - Newburgh - New
Haven - New Orleans - New York - Norfolk
Oklahoma City - Omaha - Orlando - Paducah
Paterson - Peoria - Perth Amboy - Philadelphia
Pittsburgh - Portland, Me. - Portland, Ore.
Portsmouth - Poughkeepsie - Providence - Raleigh
Reading - Reno - Richmond - Roanoke - Rochester
Rome, Ga. - Sacramento - St. Louis - Salt Lake City
San Antonio - San Diego - San Francisco - San Jose
Scranton - Seattle - Shreveport - Spartanburg - Spokane
Springfield, Mass. - Springfield, Ohio - Stockton
Syracuse - Tampa - Toledo - Tucson - Tulsa - Utica
Washington - Watertown - Wheeling - White Plains
Wichita - Wilkes-Barre - Wilson - Yakima - Youngstown



We know how important quick action and personal contact are in Finance Service . . . in checking customer credits, buying paper, and making collections. That's why there is a full-functioning C. I. T. Office in every territory.

Invite the C. I. T. representative to explain our current Radio Financing Plans in terms of your particular need. Compare the low costs he quotes. Examine C. I. T.'s record for dependability.

C. I. T. Plans cover all models of approved types of radios; also mechanical refrigerators and water coolers, electric ranges and electric water heaters.

C.I.T. CORPORATION
NEW YORK — CHICAGO — SAN FRANCISCO

For Christmas push



Children's Records

By
R. Gilbert

CHRISTMAS PLANS of record dealers should include some special promotion of children's records. The seven-inch discs make excellent leaders to portable phonograph, record player and even console combination sales. The technique is like this: Display the *Alother Goose*, *Nursery Rhymes*, *Winnie the Pooh* and other records on a special counter together with several portables. Nearby, show a record player (electric pickup) attached to a radio. A window display two weeks before the Yuletide is even better.

Then have your sales people call your customers' attention to the bright and interesting array of juvenile discs, both educational and entertaining. Play a few on your portables. Point out the possibilities in having the children learn the familiar tunes and jingles themselves without much effort on the parents' part. Once you have aroused interest, show Mother or Father how these records may be played through the loudspeaker of the family radio. The proper sales technique here will net the sale of a set or two of kiddies' songs and a turntable to play them on in case there's no phonograph already in the home.

The next step is to remind the buyer that Jimmy and Mary, coming home from college will probably like to spin off a few of the latest "swing" discs when no dance music is on the air. Should a customer show interest in the broadcasts of symphony music, demonstrate how the record player will handle the discs in the album sets by the Philadelphia or Boston Symphony Orchestras. Here you might unearth a combination prospect.

DECCA

- MOTTIER GOOSE**, by Frank Luther. Forty-two most popular children's songs. Three 10-inch discs (Nos. 252/3/4), 35c each.
- NURSERY RHYMES**, by Frank Luther. Forty-five popular songs. Three 10-inch discs (383/4/5), 35c each.
- TUNEFUL TALES**, by Frank Luther. Thirty-seven hits that go big with youngsters. Seasonal songs. Three 10-inch discs (593/4/5), 35c each.
- FAIRY TALES** (Children's stories—descriptive, with sound effects and celeste), by Frank Luther and Company. From *Cinderella* through *Jack and the Beanstalk*, etc., to *The Little Red Hen*. Three 10-inch discs (590/1/2), 35c each.

VICTOR

- RAGGEDY ANN SONGS**, by Frank Luther. Children's songs by the late Secretary of the Treasury, William H. Woodin. Three 7-inch discs in container, \$1.00.
- RAGGEDY ANN'S SONGS OF HAPPINESS**, by Frank Luther.
- WINNIE THE POOH—CHRISTOPHER ROBIN SONGS**, by Frank Luther. The best of the lot of children's records. Milne's famous characters set to music by Simson. Three 7-inch discs in container, \$1.00. De Luxe set—with pictures in four colors—\$2.00.
- SONGS FOR LITTLE PEOPLE**, by Lewis James. *London Bridge*, etc. Three 10-inch discs (22133/4/5), 75c each.

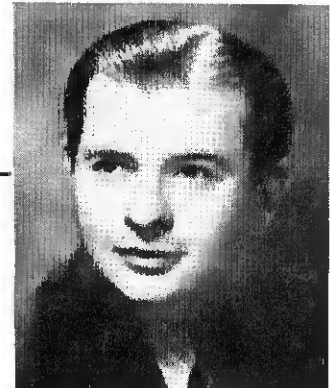

FRANK LUTHER

specialist in children's songs, as you will see by the accompanying lists, hasn't much competition

- ALICE IN WONDERLAND**, by George Baker. Picture records of Lewis Carroll's classic characters. Two 10-inch discs (17-4003/4), \$1.25 each.
- DRAMATIC STORIES: ANDROCLAS AND THE LION; THE COBBLERS AND THE CUCKOO; KING MIDAS** (adaptations by Loraine Leopold), by The Wonderland Players. Three 10-inch discs in container, \$2.25.
- THE 12 DANCING PRINCESSES** (adaptation by Loraine Leopold), by the Wonderland Players. One 10-inch disc (24553), 75c.

BRUNSWICK

- LITTLE TOTS RECORD ALBUMS**. Eleven different attractive albums, each containing four 7 in. discs with picture cards and words: Price \$1 each book.
- AESOP'S FABLES**, by Billy Murray—Bradley Baker and Company. Fifteen of Aesop's famous fables, dramatically presented in adaptations of Loraine Leopold. Highly entertaining. Three 10-inch discs (7567/8/9), 75c each.

RCA Victor is a do

give'em B

DISTINCTION

ONE BARREL is the portion of the line over \$100 and running up to the great, unrivaled D-22 at \$600. It is the irresistible attractiveness of the finer models that has sent the RCA Victor average console sale this season to date well over last year's RCA Victor average of \$102.

THE OTHER BARREL is under \$100 and here there is a lot of money to be made, too.

Look at Packard! It has great acceptance as a quality product (so has RCA) and it brought out a new Packard in the \$1000 class. What happened to Packard, since introducing it last March, has smashed all its own sales records into little bits. Why? Because the public transferred to the new car the glory of the great Packard name. They had always wanted to own a Packard, and here at last was a Packard they could afford to buy. Of course they went for it in a big way.

And then there's Lincoln. Last month it announced its medium-priced Zephyr, and practically overnight received its most amazing flood of orders from people who have "always wanted a Lincoln.

RCA MANUFACTURING CO., INC., CAMDEN, N

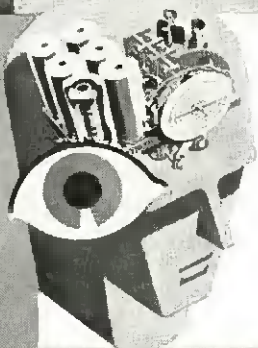

IT'S THE TOP. The great RCA Victor D-22, with 22 tubes, five band radio, automatic phonograph, with the magical Dynamic Amplifier, home and radio recording. Record reproduction was never so thrilling as this. \$600.



RCA

Double-barreled line with barrels

PRICE

What has happened with Packard and Lincoln has also happened in the case of the famous Cadillac V-8.

Exactly the same thing is occurring with RCA Victor. Sales figures demonstrate that the public chooses RCA Victor when buying quality radio. Now that RCA Victor is featuring sets under \$100, the public is transferring to the low-priced line the prestige of the luxury models. They want RCA Victor sets. We give you models at prices that mean you can sell anybody a set with the RCA Victor magic name. You not only have the prices, but you have the powerful leverage of the C.I.T. partial payment plan. You can trade up from what the prospect thinks he can afford, or trade down from what you think he ought to buy, and in any case sell as fine a piece of new RCA Victor merchandise as is available at the price. So we say . . .

FEATURE BOTH SIDES of the \$100 middle price. Get your share of the profits in the volume line as well as in the de luxe. It is this opportunity to do double-barreled selling that makes the RCA Victor line mean much more money for you.

subsidiary of RADIO CORPORATION OF AMERICA



PRICE PLUS PERFORMANCE. Model C7-6 has 7 RCA Metal Tubes, the Junior "Magic Brain," a 12-inch speaker, reception 540 to 18,000 kilocycles. A great popular model at \$84.95. All prices f. o. b. Camden, subject to change without notice.

RCA Victor

CAMOUFLAGED DUMPING ONLY SORE SPOT OF RECORD YEAR FOR RADIO INDUSTRY

Set Sales Will Top Five Million Mark for First Time—Deliveries Catch Up with Orders This Month—Metal Tubes Prove Popular

RIGHT IN THE FACE of the biggest demand for new radio receivers experienced since '29, and despite the public's ability and willingness to pay a fair price for better merchandise, the height of seasonal demand for radio witnesses an unnecessary and wide-flung dumping spree. True, we're not so bold-faced about it as formerly. But the practice—disguised as special trade-in offers (with exorbitant allowances) or what have you—prevails alarmingly as we close the last issue of *Radio Retailing* for the year 1935. Otherwise this year will be favorably recorded in radio history.

This spectacle is not confined to unknown, obsolete models. The best known makes, enjoying a national—demand reputation—genuine 1935-36 receivers—are being served up as bargains in all the large cities and in some of the smaller ones. Maybe those Radio Wholesaler and RMA trade codes, that died aborning, weren't so unnecessary after all.

Inability to control resale prices is the reason given by the manufacturers. And that stand-by of the Ages, "competition," is the justification of the retailer, who thereby admits his limitations as a real merchandiser of quality and service.

The silver lining is that many towns and smaller cities are freer from this evil than for some time; that more independent dealers are getting their price and will produce a profit this year.

1935—"The Tops"

We'll pass the five million mark for 1935 set sales. From all check-ups now before this paper, radio unit volume, including 1,100,000 car outfits and a prime export year, will top any previous year in our history.

This is not all. Business is measured in terms of dollars. From this angle retail billings also bid fair to hang up a new high.

Last minute reports from our field staff reveal that warehouse deliveries have caught up with back orders—with exceptions, of course. Also that the metal tube is growing in popularity with the public, consequently with the trade. November and December Big Bertha broadcasts and newspaper campaigns are credited with creating much of this sentiment, plus satisfactory (if not spectacular) performance.

The receiving end of the general radio industry continues its benign tolerance of broad-

casting. In other words, dealers dam with faint praise and the customary number of "old faithfuls" among the set makers use this Heaven-sent angel to trumpet their own wares only. But broadcasting, as a "natural" for educating the public in all that radio has to offer humanity, is still sadly neglected. This is due to lack of concerted effort by the manufacturing magnates. It's a big job, this getting the stations to tell our story. It's been in the works for three years. The stymie is lack of common treasury funds.

A Major Crime

Quoting one of our publicity-minded jobbers on this point:

"It's a major crime that the radio manufacturers are not using broadcasting facilities to a greater extent to sell radio to the public. Furthermore, our industry is taking no active interest in cooperating with the



S-T-S! Clear the Road!

Gong, lantern, fire extinguisher, antenna, speaker! This service wagon has the works. Not a bad rig—and gets the business for Home Radio Service, St. Louis

broadcasters who develop interesting programs or to correct the unfavorable character of some now on the air. We should even cooperate with the sponsors of programs. The broadcasters and the sponsors are supplying the life blood that keeps the set and tube manufacturers and the radio dealers and jobbers alive and yet we give nothing, not even our moral support, and take all."

CBS is authority for the statement that Philco's "Boake Carter" program has reached 30,000,000 listeners—not on the same night but in the aggregate over an 18-month period.

Elliott-Lewis Promote GE with Theater Tie-In

PHILADELPHIA — Over three million people will view the G-E Model A-65 all-metal tube radio receiver in the lobbies of their neighborhood theaters in the Philadelphia area as the result of an activity sponsored by the Elliott-Lewis Electrical Company, Inc., through over 50 G-E dealers, in cooperation with 150 theaters.

Tying in with this promotion, a trailer film is run at two theater performances each day. Each patron, on entering the theater, receives a coupon entitling him to a special trade-in allowance for his old set on the purchase of the new G-E model.

Crosley-Wincharger Deal

CINCINNATI. — The signing, last month, of a contract between the Wincharger Corporation, Sioux City, Iowa, and the Crosley Radio Corporation, this city, rounds out to an even dozen the radio set makers who now are offering the air-operated battery charger of the first mentioned concern at special, direct-to-consumer prices.

For Brunswick Parts

Schafer & Bowman, 7647 S. Wabash Ave., Chicago, advises that they are the authorized distributors for parts and service for the Brunswick Radio Corporation and for Bremer-Tully radios.

This house will carry a complete stock of replacement parts for current and obsolete models.

Trade-in Allowances for Canadian Dealers

		MANTELS					
		No. of Tubes					
Mfrd. During		3	4	5	6	7	8
1934	\$17.00	\$20.00	\$25.00	\$33.00	\$38.00	\$42.00
1933	9.00	11.00	15.00	22.00	26.00	28.00
1932	5.00	6.00	9.00	14.00	16.00	17.00
1931	3.00	4.00	5.00	8.00	9.00	10.00
1930

		CONSOLES						
		No. of Tubes						
Mfrd. During		4	5	6	7	8	9	10
1934	\$29.00	\$35.00	\$42.00	\$47.00	\$52.00	\$55.00	\$60.00
1933	20.00	25.00	30.00	33.00	38.00	41.00	45.00
1932	13.00	17.00	20.00	23.00	27.00	30.00	33.00
1931	8.00	11.00	13.00	16.00	18.00	21.00	24.00
1930	4.00	6.00	9.00	12.00	14.00	16.00	18.00

The above are suggested as maximum trade-in appraisal values on receivers in good operating condition and suitable deductions should be made therefrom with respect to inoperative tubes or other deficiencies. Figures based on eastern prices.

In the November issue of "Radio Trade-Builder," our esteemed Canadian contemporary, appears the above schedule of suggested trade-in allowances on sets from 1930 to date. It is averaged on the actual recommendation of many north country brother radio dealers and as such, should be of real practical value to merchants in the "States." Also recommended by the RMA of Canada

Raytheon Improves Metal Tube Insulation

NEWTON, MASS.—Raytheon engineers, working with one of the large manufacturers of phenolic insulating materials, have developed a new wafer insulator for the control grid of the new metal tubes. The types which will be improved by this new material are 6A8, 6L7 and 6K7.

Tests on r.f. coil efficiency have shown that the Q value of a really good coil is reduced by an undesirable amount when connected across the control grid and shield of the metal r.f. amplifier or mixer tubes if certain types of phenolic insulation are used. The new material is near the best ceramic in low losses at the high frequencies.

This improvement in grid circuit insulation will permit engineers to obtain the full advantages of low internal capacitance and short leads in metal tubes on shortwave reception.

Smith S. M. for Echophone

CHICAGO—The appointment of Douglas C. Smith, as vice president in charge of sales, and Joseph Webber, as chief engineer, has been announced by the Echophone Radio Corporation, this city.

The selection of these men to head these two departments is the final step in a program, begun several months ago, to augment and improve the entire organization personnel, states president Clem F. Wade.



The industry career of Mr. Smith has been about equally divided between retail and manufacturing, beginning with the John Wanamaker stores of New York and Philadelphia. He was responsible for getting these establishments started in the radio business, and for five years managed sales and broadcasting activities for them.

Opens Davenport Branch

DAVENPORT—Formal opening ceremonies which lasted al-



A Study in Black and White

Probably the most modern front on any radio-appliance jobbing establishment. This striking store was recently opened by Al Schneiderhahn in Davenport, Iowa

most a week featured the establishment of the Davenport branch of the A. A. Schneiderhahn Co. In addition to the high officials of the Schneiderhahn Co., headed by A. A. Schneiderhahn, Des Moines, executives of large manufacturing companies in the household appliance industry journeyed to Davenport to grace the occasion.

Jack Helliwell is in charge of the wholesale division, while Paul Henerlau will be retail division manager.

W. E. Sells RCA Shares

PITTSBURGH—Westinghouse Electric & Manufacturing Company has disposed of the balance of its holdings of Radio Corporation of America common stock, realizing an average of \$8.08 a share.

As of May 1 last Westinghouse had a balance of 60,038 shares of Radio common and 28,200 shares of class "A" preferred. The shares were sold in compliance with the terms of the consent decree entered by the Federal Court in Delaware three years ago, which required liquidation by November 21, 1935.

The appointment of HUNT-MARQUARDT INC., of Boston, as successors to the Stewart-Warner Sales Company and the Lin-scott Supply Company combines two well-established distributing organizations on a substantial financial basis and also re-aligns an association Stewart-Warner has enjoyed with A. C. Marquardt extending over a period of 20 years.

H. J. Allen Key Man For Brunswick Records

NEW YORK—H. J. Allen formerly Chicago branch manager for the Brunswick Record Corp., succeeds Harry G. Neu, in charge of sales. Closely co-operating with him will be Leonard W. Schneider in direct charge of sales promotion and advertising.

Mr. Allen will concentrate for the time being on national chain sales of 75c. Brunswick records and on chain store activities.

Mr. Neu leaves Brunswick to accept a position in the merchandising brokerage business.

Five Times Stronger

CHICAGO—Engineers of the Zenith Radio Corp. recently completed an interesting test covering the directional properties of doublet and ordinary straight antennae. The tests were made aboard President McDonald's yacht the "Mizpah" in connection with reception from DJC, Germany.

The ship itself was used as a revolving turntable so that accurate graphs of both types of antennas in every relation to the point of signal transmission were available.

Maximum pick-up was obtained with the doublet antenna at right angles to the signal—approximately 250 microvolt input. With the doublet pointing directly at the station the minimum amount, 50 microvolts, was observed.

Cleveland IRSM Meeting Attended by 1,300

CLEVELAND—Attended by over 1,300 technicians, and with 45 manufacturers participating in exhibits, the sessions of the Cleveland Chapter of the Institute of Radio Service Men, held on Sunday and Monday, November 10 and 11, at the Hotel Cleveland, surpassed in enthusiasm, size and usefulness anything which had been done before in the 19th region.

Attendance at the sessions was sustained right to the closing lecture on "The Cathode Ray Oscilloscope" by RCA Field Service Engineer W. Kimball of Camden, N. J., when an over-flowed crowd of 700, listened intently to the exposition.

American Bosch Expands

SPRINGFIELD—The United American Bosch Corporation announces the completion of a large new assembly unit in their 11 acre plant at Springfield, Mass. Work on the new unit has been rushed during the fall months so that it would be in operation for the great pre-Christmas production schedules.

The new building is a city block long and 150 feet wide. Of saw-tooth roof construction, this new addition to the plant provides the maximum of north light to create ideal conditions for delicate radio assembly and test operations.

HOW to demonstrate one or more all-wave sets successfully in the store itself, regardless of usual background noises, is explicitly told in an illustrated bulletin just issued by TECHNICAL APPLIANCE CORP., 17 East 16th St., New York. Copies are available on request.

Zimmerman of Zenith



They say he's Zenith's oldest distributor. Be that as it may, A. H. Zimmerman, Republic Electric Co., Cleveland, continues to champion the cause of the little dealer

Broadcasting at the Crossroads

Small Stations Want More Power—Fans, Program Variety—FCC Storm Center

DISSATISFACTION with the present status of radio broadcasting, while not rampant, is increasingly evident on many sides. Individual stations want more power and time; listeners want greater variety and better service; well-intentioned enthusiasts want less comedy and more religion, education, propaganda and what have you; business men, including newspaper owners, yearn to add additional stations to the crowded atmosphere.

To add to the confusion, bitter charges of censorship by the Federal Communications Commission are being widely circulated, although the Commission is forbidden by law to do anything interfering with freedom of speech (cuss words excepted).

Federal control over radio entertainment centers in the Broadcast Division of FCC, which is fully aware that a storm is brewing. Scores of bills affecting radio more or less directly were introduced during the last session of Congress, ranging from minor matters to a proposal to have the government take over and operate all broadcasting stations. Congress being what it is, most of these will die unnoticed, but one never knows. Consequently, the Commission is keeping a wary eye on Capitol Hill and meanwhile, in the hope that it will be left to deal with the situation unhampered, is studying a general re-alignment of the entire broadcasting field in an attempt to catch up with technical advances in the art since the last New Deal in 1928.

Present Allocations

The present division of broadcast channels sets aside 40 "clear channels" theoretically limited to one station each with a maximum power of 50,000 watts and 40 regional channels reserved for stations with not more than 1,000 watts power separated geographically to avoid interference. The remaining channels are crowded with local stations limited to a 100-watt maximum and seldom audible more than a few miles. About a year ago Station WLW, Cincinnati, was granted an experimental license to use 500,000 watts on a clear channel. The results were so satisfactory that the Commission is now studying a new allocation policy which, it is hoped, will give better coverage of the country, permit the addition of a number of stations to the air, grant increased power to existing stations and still avoid any increase in interference.

The catch is that the number

of clear channels would be cut from 40 to 25, the surviving aristocrats to have their power increased to 500,000 watts. But fifteen of the present clear-channel stations would necessarily drop to the regional classification, although they would presumably retain their present power rating, since a general increase in power in all classes except local is contemplated in the new plan.

Listener Would Benefit

So far as the radio listener is concerned, FCC believes that the shift would result in better reception to a larger number. The commercial angle is what hurts. Not only would the 25 big-shot stations face an expenditure of about \$250,000 each for high-power transmitters, but similar costs on a lesser scale

STORM SIGNALS

FCC Engineering Division certain to recommend cutting cleared channels from 40 to 25 and increasing power up to 500,000 watts.

Realignment of channels and increase of signal strength for many smaller stations practically assured.

NBC and Columbia dominance threatened by such moves.

Government charged with exercising undue censorship of programs verging on "political control."

A flood of "wild" radio bills from next Congress feared, most of which will be shelved until after the November elections.

Commissioner Payne demanding fixed number of chain hours for "cultural" programs.

would affect the regional stations forced to step up from the present maximum of 1,000 watts. The real rub, though, is in the advertising revenue. Under the revised conditions a nation-wide hook-up would require fewer stations and, though rate revisions might maintain

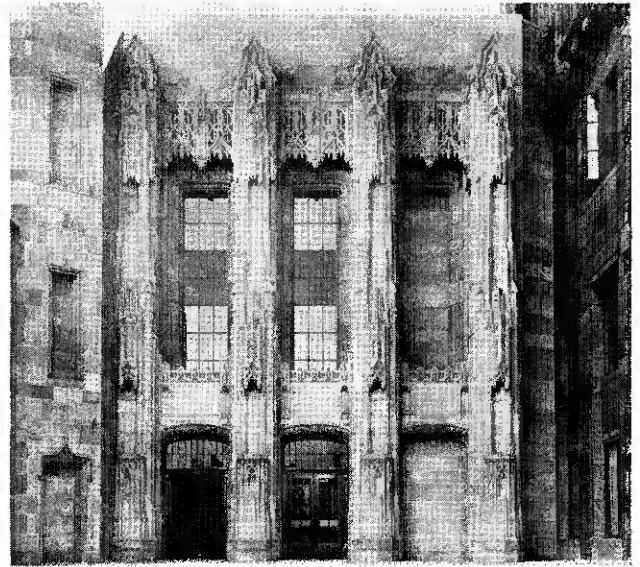

Fame and Fortune Lie Beyond

Entrance to the new WGN studios, Chicago. Four stories high, these graceful columns, at the back of the courtway between the studio building and the Tribune Tower, were hand-carved from Indiana limestone

the cost of such a broadcast at or near the present figure, the point is that the money would go into fewer pockets. Looking at it another way, more stations would find themselves dependent upon local and regional advertising for their principal sustenance.

Another angle is brought up by the rising protest against chain programs. Rural listeners, particularly, are protesting that too many points on the dial are preempted by duplicate programs. Congressional action to curb the chains is not unlikely unless it is forestalled by the FCC, which is now investigating the advisability of regulating the number of chain stations.

Censorship a Touchy Spot

While not connected with re-assignment of frequencies, the matter of censorship is another touchy spot with FCC. This being the land of the free and the home of the brave, the Commission denies stoutly that it has any thought of attempting to control programs.

Law and fact, however, sometimes differ and it is undeniably true that every broadcasting station is dependent upon the Commission for a license renewal every six months. In considering the question of renewal the Commission must by law take into consideration whether or not the past performance has been "in the public interest."

WGN May be Second Super-Power Station

CHICAGO—As soon as the smoke of the various engineering proposals clears away at the Federal Communications Commission, WGN, the *Chicago Tribune* station, will file an application for an increase in power from 50,000 to 500,000 watts power.

This would bring the number of super-power stations to two, the only station now authorized to use such power being WLW.

Juvenile Program List

A supplementary list of radio programs suitable for children has been issued by the Radio Institute of the Audible Arts, founded by Philco Radio & Television Corporation. It is being compiled by the Radio Committee of the Child Study Association of America, which is now reviewing for this purpose not only juvenile programs, but adult programs as well, that may be of interest to the younger members of the family.

The Federal Communications Commission has selected a former U. S. Navy radio expert to succeed Dr. C. B. Jolliffe as its chief engineer. He is Lieut. Comdr. T. A. M. Craven, widely known in the radio industry as well as in Naval circles.

Jobbers Hear Grunow Reorganization Plans

CHICAGO—Approval of the petition of General Household Utilities Corp., asking for permission to reorganize under Section 77B of the Bankruptcy Act, has been granted by the U. S. District Court. Judge P. L. Sullivan will allow this concern to continue in control of its assets although trustees may be appointed later on.

On Dec. 2, GHU held a fully attended convention of its distributors at Chicago. At that time president Grunow outlined a plan for a reshaping of the company's financial position under which new sinews of war would be supplied by himself and D. H. Ball.

General Household claims that it is solvent but lacks sufficient working capital to meet current obligations. Assets are placed at \$3,551,424 and liabilities, as of Nov. 1, \$2,331,342.

At the jobbers' meeting an enthusiastic reception was accorded Mr. Grunow's frank statement of conditions. Also the new line of Grunow refrigerators met with hearty approval. It was apparent that the wholesalers intend to carry on with unabated vigor and this speaks well for a happy ending to present difficulties.

Impressive Catalog

Stewart-Warner, Chicago, has brought out a beautiful catalog illustrating, in striking rotogravure pictures, the many talking points of its new line of "Ferrodyne" radio receivers.

Even a hasty perusal of this arresting piece of literature would cause the coldest prospect to want to investigate further.

DX'ing

The new Hollywood studios of the National Broadcasting Company, providing the most advanced technical facilities known to radio engineers for NBC's broadcasts from the movie capital, were dedicated last week.

The ceremonies were attended by stars of the radio, screen, stage and music worlds, business leaders and other celebrities.

Always the scene of some of the most colorful Christmas celebrations in Christendom, Germany this year will make its outstanding festivals available to the world via short wave radio. The programs may be heard over DJC, Berlin, 49.8 m. (6,020 kc.).

The St. Louis Post's new short-wave station, W9XPD, is now on the air with 31,600 kc.

or 9.5 meters. The new station, which began broadcasting October 30, is working gradually into a daily schedule. It has power of 100 watts and is of the high fidelity type, covering a tonal range of 30 to 12,000 cycles.

RR NOMINATES for membership in its PRIME MOVERS CLUB



Virgil M. Graham

To qualify for membership in our "Prime Movers Club" one must have contributed, in an altruistic sense, to the advancement of the industry he represents.

The biggest fall meeting the Institute of Radio Engineers ever held came to a successful conclusion November 20. To Virgil Graham, by common consent, went most of the credit for this affair. His untiring labors as chairman of the Rochester Convention Committee climaxed many years of unselfish effort on behalf of the advancement of radio engineering standards.

Mr. Graham has been a leader in technical committee work and has made important contributions to the advancement of radio design in his capacity, since 1931, as chairman of the Standards Section of the RMA Engineering Division.

Was chairman of the joint SEA-RMA Committee on Automotive Radio, 1932-34, and RMA chairman of the Joint Coordination Committee of EEI, NEMA and RMA on Radio Reception since 1933.

From 1923, and until acceptance of his present appointment as head of the Sylvania Application Laboratory, Emporium, Pa., Virgil was chief radio engineer for Stromberg Carlson, assisting in the development of the first S-C receiver.

RCA-NBC At Work on Elaborate Television Developments

NEW YORK—Working in secrecy, engineers of the Radio Corporation of America and National Broadcasting Company are reported to be dismantling the old television equipment atop the Empire State Building preparatory to installing modern apparatus, according to the *New York Times*.

"It is expected that the new installation will be completed in January, and that after preliminary engineering experiments, the metropolitan area will be used as an outdoor laboratory probably about April 1."

The plan is understood to provide for the manufacture of 500 television receivers of four different designs. They will not be sold publicly but will be distributed to research outposts and homes of observers to facilitate a complete check on the behavior of the images. After three or four months of observation the experts hope to be able to decide which type of receiver is most practical, also what improvements are necessary in the receivers and transmitters to make television a utility in the home. Then, as a representative of RCA Victor explained, the 'bugs' will

be ironed out of the system and the way will be cleared to offer a fool-proof receiver to the public, possibly in time for the Christmas trade in 1936. It is expected that other manufacturers will do likewise.

The images will be hurled into space by a twelve or fifteen kilowatt transmitter operating on the six-meter wave, which will carry both the picture and associated sound across a radius of thirty miles.

The pictures, approximately 9 by 10 inches, are described as "very clear," especially since a new fluorescent material has been discovered for the receiving screen on the flat end of the cathode ray tube. Receivers are expected to cost from \$250 to \$500.

A meeting was held the latter part of November by representatives of the various groups organized to develop the plan to give New York television in the springtime. It is reported that plans have gone ahead so far that a "dead line" has been established, so if the engineers make any further advances the present work will not be delayed to take advantage of them. They will be incorporated in later instruments.

I.R.E. Fall Meeting

ROCHESTER—At the fall meeting of the Institute of Radio Engineers, held in this city November 18-20, the interest of a record attendance of over 350 radio engineers from all over the country centered in the following four addresses:

New Problems in Metal Tubes, by Roger M. Wise (Hygrade Sylvania); Electron Multipliers and New Electronic

Technique, by V. K. Zworykin (Victor Radio Division); Ultra High Frequency Broadcasting, by Edwin H. Armstrong (Columbia University) and Design of Doublet Antenna Systems, by H. A. Wheeler (Hazeltine).

All these subjects are very close to the business of the radio dealer as they have a major bearing upon future developments and the trend of industrial progress.

New Engineering Laboratory



Indication of the growth, this year, of radio business is seen in the extensive enlargement plans of American Bosch. This new engineering building is but one of many alterations being made. Assembly capacity of this Springfield, Mass., concern has been doubled by the addition of a new daylight factory

NEW MERCHANDISE

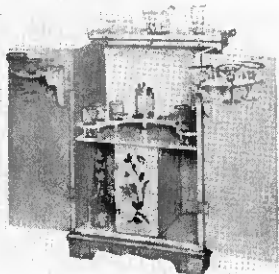

Troy Model 600A

Troy "Wonder Bars"

The Hollywood "Wonder Bar" of the Troy Mfg. Co., 1142 So. Olive St., Los Angeles, Calif., may be had in four distinctive models. One comes in desert tan, which is a light finish decorated with an attractive floral design on the doors; another is of Spanish design in antique driftwood, and the other two are ultra-modern in line.

All wood is finished in liquor-resistant lacquer and all models are mounted on four hidden rubber tired castors for convenience in moving from room to room. The glass equipment consists of 6 whisky, 6 highball, 6 cocktail glasses, an ice pail, a cocktail shaker and a pair of ice tongs. The radio is a 6-tube shortwave superheterodyne with metal tubes. These bars may also be had without radio.

Another interesting radio that Troy makes is the illustrated table set on a stand. This is a 5-tube superheterodyne.

Troy's Model 5A table receiver comes in several special finishes—imported colored mirror case in blue, green, pink or natural, or in mahogany, maple and bone white as well as walnut.

This company also makes a full line of radios in "standard" cabinets, both table and console, several of which are available in combinations of old ivory, Chinese red and antique white.—*Radio Retailing*, December, 1935.



Troy Model 5-T

Webster Amplifiers

Announcement is made by The Webster-Chicago Co., 3829 W. Lake St., Chicago, of a new four-position 15-watt amplifier. This unit, it is stated, is suitable for four crystal or velocity microphones or three crystal microphones and one phono in-

put. The entire unit is self-contained. Output impedance is tapped from 2 to 500 ohms.

Webster-Chicago also makes a four-stage, high gain amplifier, self-contained and completely enclosed. Its field excitation is for two dynamic speakers. Its output is 15 watts. Tapped output transformer. Adaptable for general public address work and party call systems.—*Radio Retailing*, December, 1935.

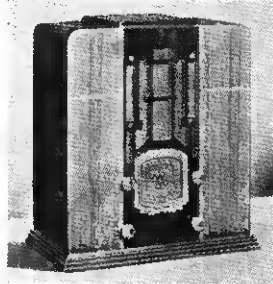

Echophone 6- and 32-Volt Sets

Model 185 6-volt battery set of the Echophone Radio Corp., 2611 Indiana Ave., Chicago, is a 6-tube superheterodyne covering from 550 to 5,000 kc. and from 5,500 to 18,500 kc. Battery drain, 1.7 amps.

Model 173 is a 32-volt farm set using 7 tubes. All calls between 18--55 and 175-550 meters may be received. No vibrator or other mechanical B-eliminator is used.

Both sets come in the illustrated table cabinet.—*Radio Retailing*, December, 1935.

Aladdin I.F. Transformers

Polyiron, a development of the Johnson Laboratories, is now used in the Aladdin Radio Industries i.f. transformers being manufactured in their new plant at 466 W. Superior St., Chicago.

The principal advantage of this Polyiron in the cores is to concentrate the magnetic field, permitting much smaller size transformers, and to increase the "Q" ratio of inductance to resistance by virtue of less copper being required for a given inductance. The distributed capacity is also reduced by virtue of less wire being used.

This small size, 1½ in. square by 2½ in. high, including the dual mica insulated trimmer, makes the transformers suitable companions for the new iron tubes.—*Radio Retailing*, December, 1935.

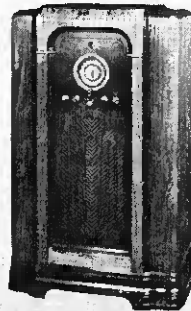
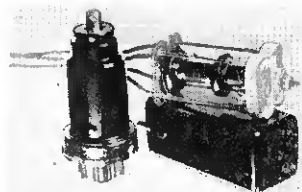

Grebe Model 120

New Grebe Radios

The newly organized Grebe Radio & Television Corp., 55 W. 42nd St., New York City, announces three table sets and three consoles for the season. These sets were engineered and perfected by the late Alfred H. Grebe.

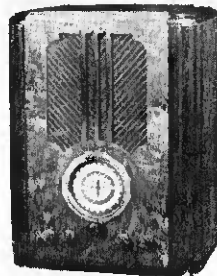

Grebe Model 9

All models are equipped with metal tubes, have full vision airplane dial, a.v.c. and Grebe compensated continuously variable "Colortone."

The table radios are: Model AHG-6, 6 tubes, three bands, \$59.50; Model AHG-9, 9 tubes, four bands, balanced high fidel-

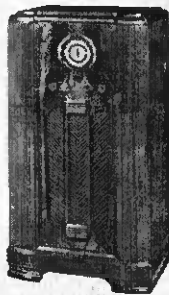

Grebe Model 90

ity system, \$89.50; and Model AHG-12, 12 tubes, five bands, (ultra-shortwave included), balanced high fidelity system, syncro-vision tuning, \$118.50.

The consoles are: Model AHG-60, 6 tubes, three bands, \$69.90; Model AHG-90, 9 tubes, four bands, balanced high fidelity system, \$119.50; and, Model AHG-120, 12 tubes, five bands,

balanced high fidelity system, syncro-vision tuning, \$159.50.

All Grebe cabinets are of figured walnut, some with two-tone effect. They are conservatively moderne in line and of the type that will harmonize with any home interior. The three band sets cover from 540-4,000 and 5,400-16,000 kc., the four band sets—140-360 and 540-18,000 kc., the five band models—140-360 and 540-36,000 kc.—*Radio Retailing*, December, 1935.

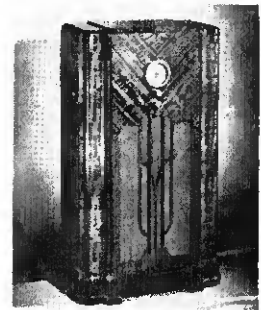

F-M Model 746

Fairbanks Morse 6-Volt Radios

Two attractive 6-volt, B-less, battery-operated radios, a table model and a console, have just been added to the line of Fairbanks-Morse Home Appliances, Inc., 430 S. Green St., Chicago.

Both sets cover from 540 kc. to 18.2 mc. in three bands. The dial is of the airplane type with illumination changes for the different bands.

The table set has a 6-in. balanced armature magnetic speaker and the console has an 8-in. speaker.

Fairbanks-Morse has made arrangements with the manufacturer of the "Wincharger" whereby this wind powered charger may be obtained with F-M radios.—*Radio Retailing*, December, 1935.

Electronometer Tube Analyzer Series 500

Many advanced circuit features to analyze tubes in an accurate, complete and speedy manner have been built into the Series 500 "Electronometer" of the Precision Apparatus Corp., 321 E. New York Ave., Brooklyn, N. Y.

It will test over 300 tube numbers including all types of glass, metal, metal-glass and glass octal base tubes.

Comes in three types, portable, counter and panel.—*Radio Retailing*, December, 1935.

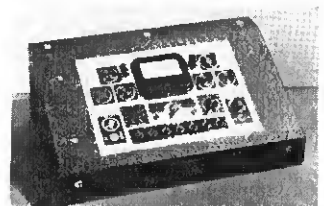

FARM POWER

(TRADE MARK)

Another Sentinel Scoop!

LIGHT POWER RADIO

Sell "FARM POWER," the latest Sentinel achievement!

Supplies power for Electric Lights, Radio, Washing Machines and other, Farm Appliances.

"FARM POWER" is an efficient power unit consisting of a gas-engine driven, 6-volt generator. Direct-connected drive—no belts to slip and tear. Compact, convenient, economically operated—and at a surprisingly low price that every farmer can afford!

It's the perfect complement to the magnificent new Sentinel Line of Farm Radio. With "FARM POWER" you have every farm power problem licked. Step out in the farm market with Sentinel for added sales! New Profits! Send in the coupon for complete details of this remarkable unit today.

LARGEST PRODUCERS OF FARM RADIO
Export Dept.: 330 W. 42nd St., N. Y., U. S. A. Cable Address: Sentinel, N. Y.

Sentinel

Sentinel Radio Corporation, 2222 Diversy Place, Chicago, Ill. Send me, at once, full details on "FARM POWER," your marvelous new power plant, and on the complete Sentinel Radio Line and the Gyromatic Windcharger.

Name
Address
City State

MAIL THIS COUPON

The SENTINEL GYROMATIC WIND-CHARGER

With the Sentinel line you can overcome any emergency by battery charging problems. In addition to "FARM POWER" you have the sensational Gyromatic Windcharger that automatically charges all other batteries without cost. This compact, weatherproof, 6-volt generator, driven by a 5 foot propeller, takes advantage of the lightest winds, blowing from any direction, to charge a battery radio.

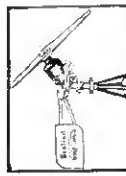

It's automatic and foolproof—this battery-charger gets up the Gyromatic outout operates when batteries are fully charged.



Write for complete details of our unusual sales plan on the Sentinel Gyromatic Windcharger.

Sentinel—

The most complete line of FARM RADIO

- ★ 2 volt
- ★ 6 volt
- ★ 32 volt
- ★ Air Cell and
- ★ Windcharger Models

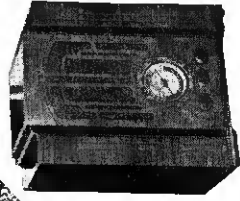

HERE'S the finest line of farm radio. A model for every type of operation, priced for every purse.

Sentinel, pioneers in farm radio, have exceeded every former effort. In appearance, in performance, in efficiency, today's most outstanding line.

Send the coupon immediately to get full details on the marvelous Sentinel Line for 1936.

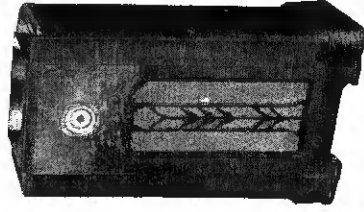

MAIL THIS COUPON

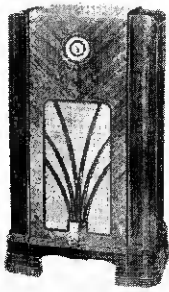

Fada Models 150CA,
160CA

A new console has been added to the line of the Fada Radio & Electric Co., Long Island City, N. Y. It is available with either five-tube chassis using metal tubes or six-tube chassis using metal tubes throughout, listing at \$59.95 and \$69.95, respectively. Both chassis cover world wide tuning range.

This is a 40-in. cabinet incorporating a large dial of special design. A 10-in. dynamic speaker is used in connection with either type chassis.

Both of the chassis are available in a table type cabinet listing \$39.95 and \$52.95.—*Radio Retailing*, December, 1935.

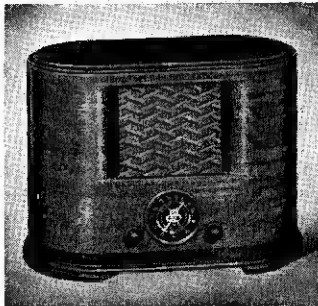

De Wald Model 615

Illustrated is one of the leading sets of the new 1936 line of Pierce Airo, Inc., 510 Sixth Ave., New York City. It is known as the Model 615 and is designed for both foreign and American reception. It has duo-colored aero dial (illuminated) and uses metal tubes. Operates on a.c. or d.c. and lists at \$37.50.—*Radio Retailing*, December, 1935.

Cathode Ray Test Equipment

The United Sound Engineering Co., 2233 University Ave., St. Paul, Minn., is making cathode ray test equipment for testing high fidelity radios.

Type CR-3 cathode ray oscillograph is used for qualitative analysis of a.f. and r.f. circuits. The net price complete is \$84.50.

The beat frequency audio oscillator, Type CR-4, is a portable a.c. operated instrument, \$69, complete.

Type CR-5 frequency-modulated r.f. oscillator is used with the cathode ray oscillograph for visual alignment of radio sets. It accurately aligns radio sets faster and easier than any other instrument or combination of instruments on the market, the manufacturer claims, \$85.—*Radio Retailing*, December, 1935.

1936 Radiobars

The new 1936 Radiobars are now ready at the plant of the Radiobar Co. of America, 711 McKinley Ave., Los Angeles, Calif. All Radiobars contain 1936 Philco radios.

They come complete with highball, cocktail and whiskey glasses, decanter, ice container, mirror and electric light.

A wide variety of cabinets is offered ranging from the conservative to the ultra-modern. Any Radiobar may be obtained with the smart antique white finish.

The prices, complete with radio and with accessories, range from \$99.50 to \$347.50.—*Radio Retailing*, December, 1935.

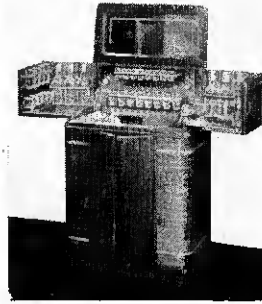

"Microvox" Microphone Volume and Tone Control

The "Microvox" is designed to provide accurate and positive control of sound reproduction from the microphone itself instead of from the amplifier, offering more efficient sound reproduction, greater convenience and the means of eliminating "feed back" interruption. Microphone gain (or sound volume) can be changed from a whisper to full amplifier volume.

When used with an orchestra the Microvox can be set to bring out soloists, feature performers or any desired section.

The Microvox is designed for use with any p.a. system, and is obtainable either with or without mike. It is licensed by the Microvox Corp. and manufactured by the Colortone Products Corp., Sturgis, Mich.—*Radio Retailing*, December, 1935.



Federal "Exact Duplicate" Replacements

The Federal Engineering Co., 286 Mercer St., New York City, offers a complete list of "exact duplicate" power transformers, condenser blocks, audio transformers, chokes, audio packs, power packs, by-pass condensers, etc.—*Radio Retailing*, December, 1935.

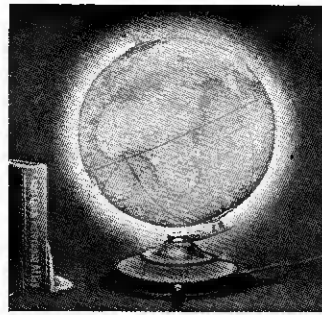

Cram Illuminated Shortwave Globe

An authentic, detailed map in colors showing all the shortwave stations with call letters may be obtained from the George F. Cram Co., 32 E. Georgia St., Indianapolis, Ind.

The unusual feature of this globe is the fact that it may be illuminated. A switch converts it into a glowing ball making it easier to read and adding to its decorative appearance. Base is finished in Venetian bronze with gold high-lighting. Retail price, \$5. Supplied to dealers for around \$2.50. These globes make excellent premiums and are useful for promotion purposes, etc.

In addition, the Cram Co. makes a complete line of globes in the 7, 9 and 12 in. sizes.—*Radio Retailing*, December, 1935.

"Troubadour" Radio

The louvers on the "Troubadour" table set of the World Radio, 1072 Atlantic Ave., Brooklyn, N. Y., are so designed for a technical reason as well as for decorative purposes. Sound wave radiation is spread over a range of 270° by building the dynamic speaker in a diagonal position. This is an all-wave set using all-metal tubes. World Radio's method of tuning with a "Detector-Light" dial and individual wave band indicator are incorporated. Phonograph connection is provided.—*Radio Retailing*, December, 1935.

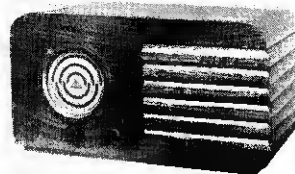

Bruno Microphones

Models SK-2 and SK-4 microphones have been brought out by the Bruno Labs., 20 W. 22nd St., New York City.

Model SK-2 velocity mike, in the lowest price class, comes in a new type case which eliminates cavity resonance from this source. Another feature is the use of oversize 36 p.c. Cobalt steel magnets.

Model SK-4 has improved output level and frequency response accomplished by a new design of magnetic circuit and case. The magnetic circuit incorporates super-size magnets of the newly invented nickel-aluminum alloy type.

By means of a new swivel system the SK-4 mike may be turned in any direction at the touch of the hand.—*Radio Retailing*, December, 1935.

Sentinel Wind Charger

For owners of 6 volt battery sets the Sentinel Radio Corp., 2322 Diversey Blvd. Chicago, offers its wind driven charger under the trade name Sentinel "Gyromatic."

The Gyromatic has positive automatic speed control regardless of wind velocity; positive throwout, neutralizing propeller under all conditions; an especially designed propeller for easy starting in low winds; metal sheathing to protect the propeller from dust, sand and sleet storms and a rotogrip distributor which maintains double tension contact yet permits free rotation of power head.

When the Gyromatic is connected in parallel to several batteries a reserve supply of electric current may be stored for use in lighting the home, garage, work shop, etc. \$39.50.

Sentinel also makes a line of farm radios including a set for every type of battery operation ranging in price from \$29.95 to \$79.95, all prices complete with batteries.—*Radio Retailing*, December, 1935.



Crolite "Magicores"

Crolite "Magicores" are an entirely new development of the Henry L. Crowley & Co., West Orange, N. J. These tiny cylinders of magic metal are simply high-frequency cores for use in r.f. and i.f. transformers and coils, in place of the usual air core. They permit of twice the gain, better than twice the selectivity and remarkable compactness, the release states.—*Radio Retailing*, December, 1935.

"Mark-Time" Radio Switch

A particularly attractive portable radio switch to turn the radio off and on has just been placed on the market by M. H. Rhodes, Inc., Rockefeller Plaza, New York City. This switch covers a 12-hour period so the radio will shut off after retiring and awaken the sleeper with soft music in the morning.

It may also be used, of course, to defrost refrigerators, time sun lamp exposure, etc.—*Radio Retailing*, December, 1935.

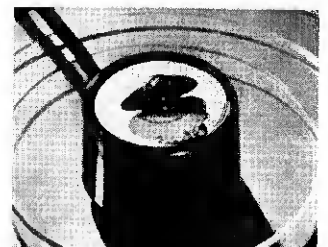



What EXCLUSIVE Feature

marked the first genuine improvement in electric refrigeration for many years?

What EXCLUSIVE Feature

created a sensation in the refrigeration industry in 1935?

What EXCLUSIVE Feature

made a refrigerator carrying a well-known name EASIER TO SELL?

What EXCLUSIVE Feature

combined with all other worthwhile refrigeration features won amazing consumer acceptance in 1935?

What EXCLUSIVE Feature

was awarded 1st Prize as the most useful household invention by the National Inventors Congress?

What EXCLUSIVE Feature

will increase YOUR 1936 refrigerator sales?

... the Answer is

FAIRBANKS-MORSE *Conservador*
REFRIGERATOR

It will pay you to know ALL the details about the Fairbanks-Morse Conservador Refrigerator. Wait for the announcements before you commit yourself to conventional lines. For advance information, write Fairbanks-Morse Home Appliances, Inc., 430 S. Green St., Chicago.

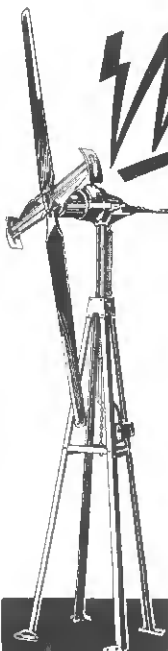

WINCHARGER
A PROVEN
SUCCESS

Not only for the user, but for the jobbers and dealers who are putting themselves at the head of the parade with Wincharger. The 6-volt battery charger enthusiastically indorsed by fourteen leading farm radio manufacturers and offered to the public not as an experiment, but as a proven success.

Get into the ranks of the winners. Don't take chances of diminishing sales and profits. Sell farm radios, special 6-volt batteries and Wincharger combinations. Win with a winner.

Over 40,000 sold in the last 4 months. Write for details.

WINCHARGER CORPORATION
World's Largest Manufacturers of 6-Volt Wind Driven Battery Chargers.

MADE IN
2
SIZES

2700 Hawkeye Drive

SIoux CITY, IOWA

MANUFACTURERS OF 32-VOLT WINCHARGERS SINCE 1927

★ HIGHEST QUALITY ★
FIRST-CLASS ENGINEERING
★ PROFIT TO DEALERS

DEPENDABLE

Glass and Metal Radio Tubes

Ken-Rad Radio Tubes

KEN-RAD Radio Tubes are real money-makers. Write us for complete dealer proposition. Here's opportunity for increased business. Act now! No obligation.

LONG LIFE ★ ★ ★

THE KEN-RAD CORPORATION, Inc., Owensboro, Ky.
Division of The Ken-Rad Tube and Lamp Corporation
Also Mfrs. of Ken-Rad Incandescent Electric Lamps

While the City Sleeps (Continued from page 24)

of the fact that their "hot prospects" had been sold during the campaign, they rolled up a total of almost \$1,400,000 in 24 hours. No special prizes were offered on "Zim's Day."

No Advance Preparation

Salesmen were totally unprepared for this activity. No advance ballyhoo had been staged. Cleveland headquarters merely sent a letter, marked confidential, to all distributors, suggesting that they set aside November 1 as "Zim's Day." They were urged to call in all their salesmen and as many of their dealers as possible for an early morning breakfast on that day. At that time the sales organization was given its first information concerning the all-day, all-night drive. After the breakfast, salesmen called up their homes to inform their families they "wouldn't be home until morning."

To present some idea as to sales re-

sults: R. Cooper, Jr., Inc., Chicago distributor, sold a total of \$166,000 worth of appliances on that day. Rex Cole, Inc., New York, reported \$132,000; Caswell, Inc., Detroit, \$91,000; Philip H. Harrison Co., Newark, \$69,000; Electrical Household Appliances, Inc., Dallas, \$69,000; George Patterson, Inc., St. Petersburg, \$74,000; Judson C. Burns, Inc., Philadelphia, \$52,000; George Belsey Co., Ltd., Los Angeles, and Electric Appliances, Inc., San Francisco, \$45,000 each. All figures are retail sales to the consumer.

More complete electric kitchens were sold on "Zim's Day" than had been sold during the last three months, according to Mr. DeJen. Also more ranges and dishwashers were sold than during that quarter-year period, many distributors reporting more sales of ranges than refrigerators—an unusual fact. At the same time, more electric refrigerators were sold on this one day than were sold during a whole week of the peak

selling season of early springtime.

"There is a certain amount of sales psychology attached to the one-day's stunt," says DeJen. "If we had asked the distributors to stage a twelve-hour drive it wouldn't have been so unusual. But when we asked them to have their salesmen and dealers work *around the clock*, there was an element of novelty, it captured their imagination. We asked for such a seemingly impossible thing that they accepted the challenge with alacrity.

"Zim's Red Letter Day" drive had no advance ballyhoo, except the letter to distributors asking them to participate. With the letter went suggestions, such as the staging of an early morning breakfast for salesmen, at which they received information of the day's event for the first time. Most distributors served the breakfast Friday morning and a midnight lunch Friday night. Salesmen then went back on the sales job."



54% Make Money on Trade-Ins (Continued from page 13)

the remainder as junk. Three per cent donate trade-ins to institutions, throw them away or sell them very cheap to other dealers. The throw-aways are as rare as hen's teeth. It may be said of the used radio, as of the pig, that nothing is wasted except the squeak.

Re-conditioning is an extremely common practice, much more so than one would suspect prior to actual investigation. Fully 80 per cent of all dealers appear to recondition sets in good enough condition to warrant it, so important do they consider re-sale income. Some guarantee these receivers for as long as 90 days. Most dealers re-sell trades for spot money or 30 days. But \$1 down and \$1 weekly, with repossession after missing the second payment, is not uncommon. There isn't much cash tied up in used sets so the tendency to sell on time, if necessary, appears to be growing.

Disposal methods vary. We list those in common use in what we consider their probable order of merit:

1. Advertising in the classified columns of local papers.
2. "Special Today" window display for price-buyers.
3. One-price sales when sufficient stock accumulates.
4. Dollar-a-day reduction sales.
5. Rentals.

Then there are methods new to us, some of which are quite novel. One dealer makes a small cash offer. If the customer is dissatisfied he agrees to advertise it in the classified section of a newspaper at the store's expense for three days. If the customer gets a buyer for more money, well and good. If not, it has been demonstrated that the original offer was fair.

The big trick seems to be the unearthing of buyers too poor to buy new sets, or the sale of good big trades to people who can only afford small new types on which there is not much profit anyway. The new set market is injured, of course, but the psychology seems to be . . . and it has some merit . . . that a bird in hand is worth

two in a bush. The chief danger appears to be the tendency of some new set prospects to buy a trade from somebody for \$2, sell it again to another shop at a nice, fat profit when they buy a 1936 model.

"Maybe Not, . . . YOU Try!"

A certain dealer who shall be nameless, answered one of our questions very neatly indeed. We asked: "Do you believe your present method of handling the trade-in problem is the most effective?" He replied: "Maybe not . . . YOU try!"

Okeh. But don't expect any rabbits out of the hat, mister. The trade, by and large, is doing pretty well with its trade-in problem.

If we were still in the retail business instead of on the edge of it looking in we'd probably just "horse-trade" on each individual transaction until a profit appeared to be certain. We doubt if we'd establish any hard and fast maximum allowance figure, or refuse point-blank to take trades on the cheaper sets. Something tells us that rules are a poor substitute for good judgment.

We would be inclined to base our allowances on the probable re-sale value of the trade rather than upon the new set margin as observation leads us to the conclusion that radio discounts are not so broad, even on special deals, that the average dealer can afford to cut much from his gross and still come out at the end of the year ahead of the sheriff. Competition would probably red-flag us into giving away our shirt once in a while in order to beat a competitor to a sale. But when we did we would thoroughly deserve the kick in the financial slats eventually resulting.

We think we would expect to make a small profit on trade-in re-sales. Not enough to pay the French war debt, but nevertheless something. This seems to be possible, too, judging by our survey, if one avoids taking

in stuff as useless as last year's birds' nests, bases the allowance on the probable re-sale value rather than on a roscate picture of new set volume.

We'd re-sell trades ourselves and make certain that they were re-salable before we took them in. The automobile business does it and there are no Pollyanna squawks about disruption of the new set market. It would be nice if we could still build bonfires, but the practice no longer seems economically sound.

If we took in junk at all you can bet your bottom dollar that it would only be to sell high-priced new merchandise on which there was a broad discount. And you could put our allowance in the corner of a gnat's eye without impairing its vision.

A number of dealers suggest publication of a blue-book of standard trade-in values and we agree that this would be nice. But we rather doubt if many dealers would abide by such standards at the present time, even if we had them. A book of this sort was put out some years ago, but the trade used the figures to show customers what the other guy allowed, cutting from there.

Current "horse-trading" tactics are not a bad solution for the trade-in problem. If anyone can think of a "better 'ole" our columns are wide open for discussion.

Things No Radio Can Do

(Continued from page 22)

stacles and arriving at the receiving antenna slightly out of phase with the more direct signal. In other cases, clear channel reception may be marred by the presence of interference at night from night sky wave signals from powerful stations on the neighboring channel. Such allocations as WCAU and WINS, 85 miles apart on neighboring channels, both operating simultaneously during at least a part of the night hours, do produce cross-channel interference in some areas between the two stations. This, again, is the type of information which the dealer affected should possess.

In making a demonstration, either in the store or at the home, specific comment should be made as to the performance of stations. For example:

"This is station WEEU at 830 on the dial. It is the loudest station heard here, although KYW, WCAU, WJZ, WOR, WABC, WIP and WFIL are good during the day. You will miss WEEU at night, because it is not licensed for evening transmission. WCAU and KYW are our principal night standbys; you can rely upon them to be steady and clear under all conditions. WFIL and WIP are not satisfactory at night because of interference which appears after sunset, due to the operation of other stations on the channel.

"But there is no shortage of night programs. Aside from WCAU and KYW, which are steady and highly satisfactory, you will find WLW, WHAS, WBT, WTAM and WGN about the most reliable. Shall I write them down for you and list their dial positions? It might be a good idea for you to have the information, inasmuch as certain other stations, such as KDKA, WHAM, WGY, WABC, WOR and all the big New York City stations, though louder, are at a distance such that they tend to fade or vary a great deal. These stations are therefore not as satisfactory as the more distant stations in Chicago, Cincinnati and Cleveland."

This particular explanation fits the situation in eastern Pennsylvania at a point just out of reliable reach of Philadelphia regional stations at night.

DEPEND ON SYLVANIA

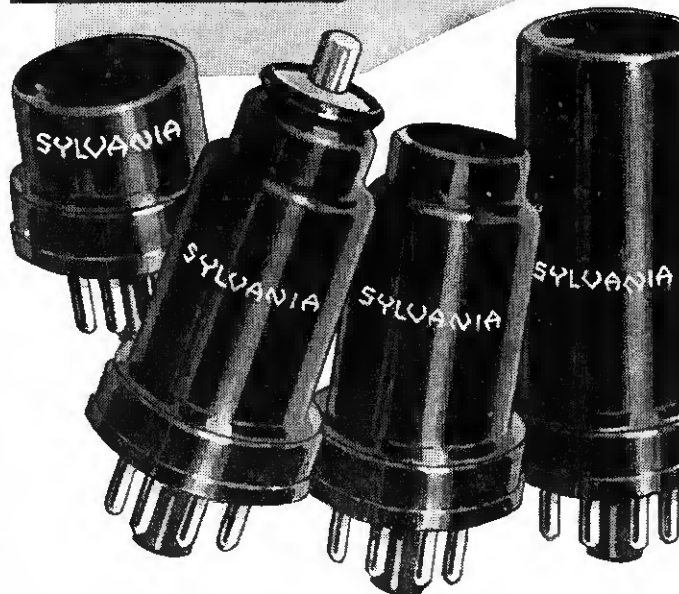

For three years the largest supplier of tubes for original equipment, SYLVANIA was among the very first to supply substantial quantities of all types of metal tubes to manufacturers, jobbers and to the export trade.

● Jobbers and retail men know Sylvania tubes. They know they're good tubes . . . that they can depend on them. That's because they're *set-tested* . . . actually tested in a receiving set before they're shipped to you.

And now, our success with the new metal tubes has enhanced our position as the largest supplier of glass tubes for original equipment. For Sylvania metal tubes have the same high standard of quality you expect and receive from Sylvania glass tubes.

Whether you're ordering the new metal tubes or the familiar glass tubes for replacement, specify Sylvania! You'll have a good tube and you'll be able to take care of your trade.

FREE Technical Supplement on the new metal tubes will be sent you on request. Address Hygrade Sylvania Corporation, Emporium, Pa.

SYLVANIA

THE SET-TESTED RADIO TUBE

© 1935, Hygrade Sylvania Corp.

DEPENDABLE SINCE 1922

1935 has been good to the radio industry, to our customers, and to ourselves. For this we are truly thankful.

Now we're faced with a new year, and we face it with confidence. It is fitting, therefore, to renew our pledge that the greatest measure of value will continue to be built into Echophone radios—just as it has been since 1922.

CLEM F. WADE,
President.

ECHOPHONE
RADIO CORPORATION
2611 Indiana Ave. Chicago



"Noise-Master" makes every receiving set a BETTER set. Electrically AUTOMATIC in operation. Eliminates "man-made" static on both broadcast and short-wave lengths.

List price . . . **\$6.75**

Also available with special transformers for European broadcast bands . . . list, \$7.00

CORNISH WIRE CO., Inc.
30 Church St., New York City

**"AMERICA'S
OLDEST RADIO MANUFACTURER"**
HOWARD
SHIPPED MORE RADIOS IN NOVEMBER
THAN IN ANY MONTH OF ITS ENTIRE
HISTORY! THAT'S INCONTESTABLE PROOF
OF QUALITY AND SALEABILITY.
HOWARD RADIO CO.
BELMONT AVE.
CHICAGO

Big, Shrewd and Vulnerable

(Continued from page 21)

\$5,000 one, and in percentage very much less. Some department stores run accounts as high as half a million dollars a year with a single distributor—and they always pay their bills. Combine these factors with the prestige and sales volume and you find the reason for longer discounts.

Certainly, large stores with reputations to maintain are desirable accounts for any manufacturer. It was quite natural that as radio names were made, and then became associated with the long-established reputations of the department stores, that their sales should increase.

Operating Costs

The cost of running a radio department in a large department store will range from a low of 15 per cent to a high of 50 per cent, both of which figures are personally known to me. The average is close to 40 per cent. These costs vary rather sharply with changes in sales volume. Expense, expressed in percentage of sales, may decrease as much as 2 per cent per \$10,000 sales increase. There is then, a constant endeavor to hold and increase volume.

Most department stores plan their operations, sales, stock, etc., from three to six months in advance, based upon recorded experience of previous years and present conditions. BEAT LAST YEAR is a daily, weekly, monthly watchword. When sales, or stock, do not conform to plan, the reason is quickly sought for—and corrected.

Under this type of operation, slow-moving radio models are quickly located, and since sales volume changes often reflect price changes, the pricing practices of competitors are also watched. Certainly department stores cut prices, but from necessity rather than choice.

When a model does not sell, it is reduced, just like any other piece of merchandise would be, for the same reason that a loss thus quickly taken is much less than such a loss deferred.

If department stores expect to stay in the radio business, they must sell at prices comparable with their competitors, and so long as "extra" trade-in allowances and discounts for cash are common practice you will find department stores selling at less than list prices. Remember that department stores are run by merchants and that radio represents but a small part of their total sales. The pricing of merchandise in department stores is first on the direct basis of cost. But when it does not sell at that price, markdowns are taken. The inflexible law of supply and demand determines the selling price.

Few department store radio departments are continuously operated at a profit. The cost of maintaining a service division to insure the satisfaction of customers for the general protection of the store's reputation comes high. I have known these costs to run as high as 15 per cent of sales. The usual figure is about 6 per cent with the trend downward. That is where profits usually go. The cost of satisfying the customer must be paid. If any store attempts to save money at the expense of customer satisfaction, sooner or later that store will pay a much greater price in lost business.

Department stores, in general, are operated by keen merchants, supported by facts and recorded experience, but they are not by any means infallible, nor have they any monopoly of merchandising brains.

Department stores may appear to operate on a day-to-day basis, but actually they have a long range policy and merchandising objective to which they stay pretty close.

That is a basic difference from most small stores, who seldom have either a policy or an objective and drift more or less with the tide. Perhaps that is the real reason why so many small retailers spend so much time minding the other fellow's business and so little minding their own.

Trade In and Selling Policies

Department stores are about evenly divided as to trade-in policies.

Macy's, who sell only for cash, and "at 6 per cent less," give NO trade-in allowance, and they are right in the heart of the replacement market, too.

Some stores allow as much as 30 per cent when the new set lists at over \$100. Some allow appraisal value only, but most stores set an arbitrary figure of 20 per cent of the purchase price of the new radio.

Few stores use outside crews on radio. With so wide a variety of merchandise the customer comes to the store. Macy's, for instance, report that they serve an average of 135,000 customers every day. Really no reason for going *outside* to expose customers to the merits of your merchandise under such conditions.

The basic trouble with the radio game is not the department store, or the chains or the "gypts." It is very largely the natural result of the sudden growth of an infant industry, of a large number of individualists with the get-rich-quick urge. It could not be reasonably expected that these men would think in terms of the common good or would conduct their business on a long range plan much less make personal sacrifices for the good of the future industry. But these conditions are with us. Yapping can do no good and may easily do much harm by arousing animosities and creating needless rivalries.

"To the Small Dealer I Say"

Every type of retail distribution is vulnerable in some point.

To the small retailer I say, search out these weak spots of your competitors. Make their weaknesses your own strength.

Chains are usually long on *price* and *trading*, but are frequently short on service and consumer satisfaction.

Department stores are long on customer satisfaction and service, have a long range policy and plan, but are mechanical and impersonal in their customer relations. This is a very important weakness.

You can be very personal, know your customers by name, remember their birthdays, insist upon their satisfaction with every sale and base your policy on the fact that *we are now definitely in a replacement market where many factors are more important than price.*

Go long on service, aim your business plans well into the future, meet your customers in their homes with your new merchandise—and thus strike at the Achilles heel of your competitors.

Forget the other fellow and all your pet grievances. Remember that a gypped customer will steer clear of the gypper. "Mind your own business and your business will mind you."

The radio business now has leveled off to a definite replacement market. In this field you have many advantages because the personal, follow-up factor will be all-important.

Your business policy from now on should be to make a customer, not just to sell a set. Repeat business will be a vital thing.

Adopt a long-pull policy, based on these theories—and then have the courage to stick with it.

PARDON MY EXCITEMENT!



BUT LET'S LOOK AT THAT
GIBSON '36 REFRIGERATOR FIRST!

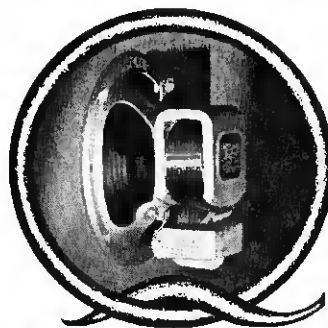

THE ONLY SPEAKER
WITH ARMoured
FIELD COILS.

QUAM
SPEAKERS



QUAM-NICHOLS CO.

1674 Broadway New York
209 W. 17th Street Los Angeles
1623 W. 74th Street, Chicago
30 9th Street SAN FRANCISCO
303 E. Pike Street Seattle
3037 Knox Avenue, S. Minneapolis
"AMERICA'S LARGEST SPEAKER MANUFACTURERS"

NEW READRITE ALL-WAVE SIGNAL GENERATOR

Uses Plug-in Coils

Five Plug-in Coils cover 5 frequency bands from 100 to 20,000 kc. All frequencies fundamentals and stabilized.

Model 554-A—Complete with batteries and two No. 30 tubes.

DEALER NET PRICE ONLY **\$14 40**

NEW *Readrite*
TUBE TESTER
TESTS ALL TYPES
METAL AND
GLASS METAL

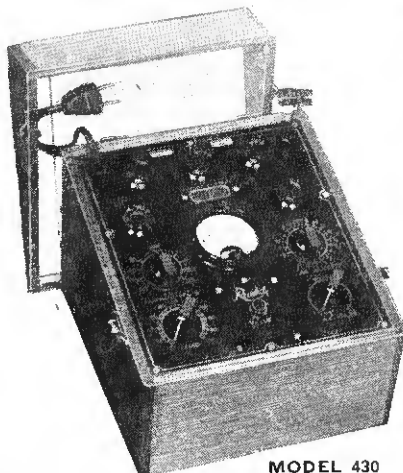

MODEL 430

Equipped with Shadow type A.C. Meter for adjusting line voltage. Leakage and short test. Tubes tested under load.

Model 430—Complete with Triplett Instrument GOOD-BAD scale. **DEALER NET PRICE..... \$18 00**

Model 431—Same except has Readrite GOOD-BAD meter. **DEALER NET PRICE..... \$14 40**

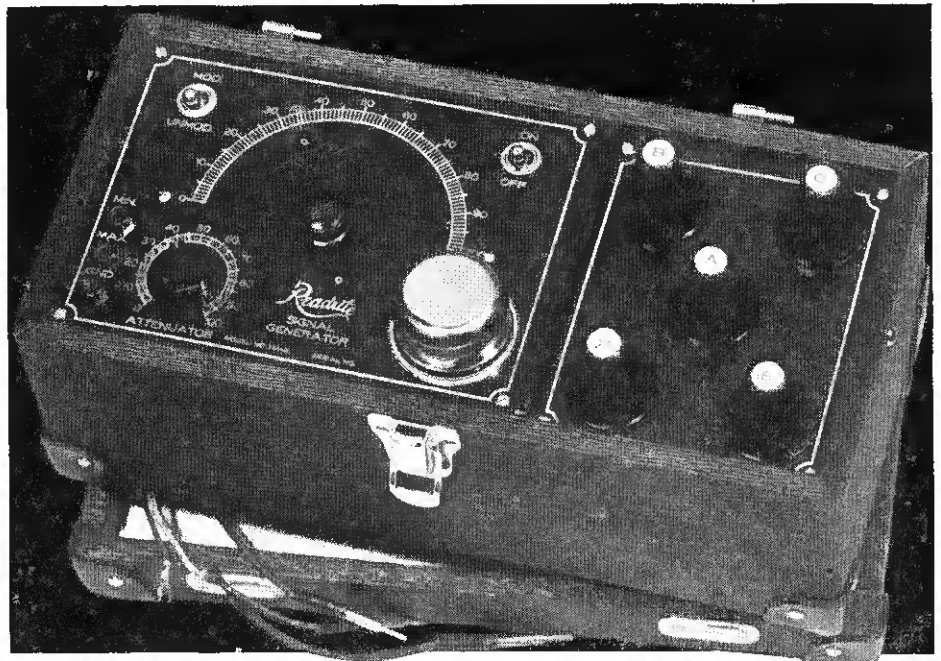

MODEL 554-A

The new Readrite All-Wave Signal Generator includes all improvements of present day engineering. The use of plug-in coils permits any new frequency band to be added by a new coil.

Extra wide scale permits accurate frequency settings from the large calibration curves supplied. Besides having all frequencies fundamentals, this new Signal Generator is completely shielded and tube modulated. Panel is attractively finished in silver and black.

Model 554-A—Complete with batteries and two No. 30 tubes and installed in leatherette covered portable case with detachable cover. **DEALER NET PRICE..... \$14 40**

Where reliability is desired at low cost turn to Readrite. All Readrite merchandise is built rugged to withstand hard usage. It will give dependable performance over a long period of time.

Other Products

Readrite manufactures all types of testers used for servicing Radio Sets, including Set Testers, Tube Testers, Resistance, Continuity and Capacity Testers, Point-to-Point Testers and inexpensive Indicating Meters.

Write for catalogue—See your jobber.

Readrite

TESTERS AND METERS
RELIABILITY AT LOW COST

THIS COUPON BRINGS FACTS

Readrite Meter Works
1220 College Drive
Bluffton, Ohio

Please send me full information on
Model 554-A _____ Model 430 _____
Model 431 _____ Catalogue _____

Name _____

Address _____

City _____ State _____

SERVICE SECTION

CIRCUITS of the MONTH

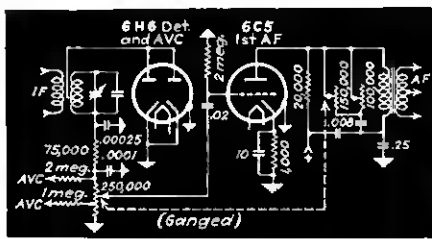

Delayed A.V.C. Connection

When servicing Stewart-Warner's models 1381 to 1389 note that a.v.c. voltage developed by the 6H6 is *not* applied to the 6K7 second i.f. stage. Both the grid and cathode of this tube are returned to ground.

The connection between the cathode of 6K7 and the cathode of the 6H6 is merely to supply initial bias to the 6H6. The a.v.c. tube, in other words, is biased by the drop across the cathode resistor of the 6K7 and control action cannot start until this bias is overcome by a strong signal.

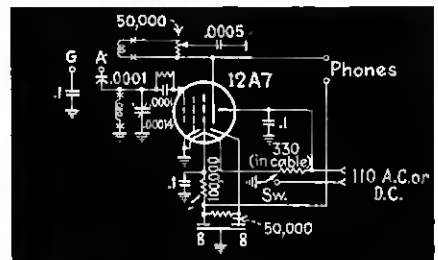

Diode Input Tap Improves Selectivity

When checking through the circuit of GE's Model A-82 receivers you may be puzzled regarding the purpose of the tap on the secondary of the second i.f. transformer. It is included to give a better impedance-match to the diode detector, which improves selectivity. There is a slight reduction in voltage available at the diode but this is not serious owing to the ample r.f. gain of preceding stages.

Note, also, that plate current for the first audio tube does not flow through the primary of the coupling transformer. Similar isolation of transformer primaries with respect to d.c. plate current may be found in certain high-gain public address amplifiers. By avoiding direct current flow in the transformer primary higher inductance can be obtained with the same number of turns, since the core-saturating effect of the d.c. is eliminated. In the second diagram an equivalent bridge circuit is shown. It balances out any hum which may exist between B plus and ground.

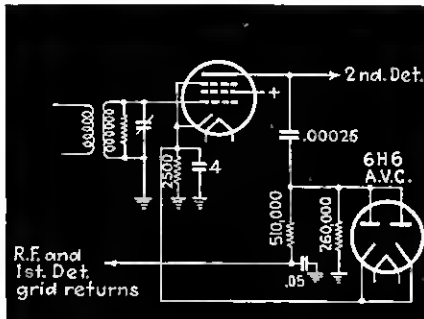

One-Tube Universal Allwaver

This single tube kit made by Radio Constructors Labs. of 136 Liberty, New York, may interest men who wish to use it as a "builder-upper" with which to interest experimenters in the short-waves and later develop big set business.

Cheap to build (the kit lists at \$3.95 with 4 plug-ins covering 12 to 200 meters) the job works on a.c. or d.c. 110 volt lines, using a 12A7 combination half-wave rectifier and pentode. The circuit is a simple regenerative one without audio amplification, using a resistance-capacity filter in the pack and a 330 ohm line cord to cut the supply down to the required heater potential.

With the exception of the tube, designed as we recall for Kadette several years ago, the parts are standard and will be found around most shops.

Tunable Doublet Antenna

McMurdo Silver has a new allwave antenna system, called the "R9+," which is particularly flexible and should work well with any make or type of receiver, irrespective of its input system. The four switches shown are ganged.

With the panel control set at position 5 one leg of the antenna is grounded, the other connected directly to the antenna post of the set. This position, approximating an ordinary "L" type of antenna with the effective download semi-shielded by the other, is recommended for broadcast band reception.

With the control set in position 4 the two legs of the doublet carry straight through to the antenna and ground posts of the receiver. No ground is used and the system works as a standard low-impedance line doublet. Match between the downloads and the top is accomplished by the splaying out of the twisted pair to the positions shown. Impedance match at the set end is ignored. Like other systems of this type maximum signal pickup is encountered on the frequency to which the top is tuned

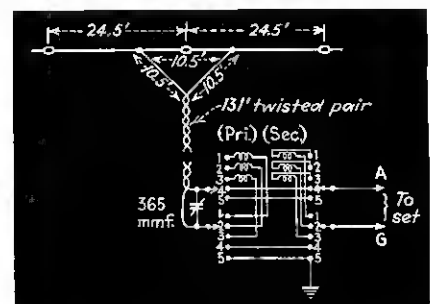
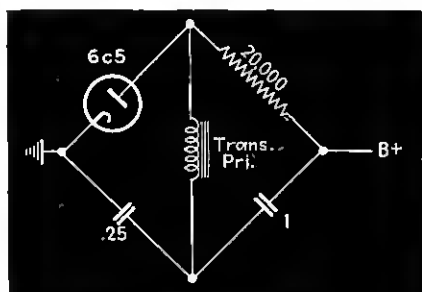



On behalf of the Service and Test Instrument branches of the Radio Industry the Supreme Instruments Corporation acknowledges with deep appreciation the action taken independently by individual manufacturers, and subsequently by the Radio Manufacturers' Association, to correct the unfortunate situation caused by the "blanking out" of octal tube sockets in some of this year's models of radio sets.

A continuation and aggravation of this condition would have resulted in an unjust economic burden being placed on the individual radio serviceman due to the necessity of purchasing an extra adapter for each non-standard socket commercially issued.

We take pride in listing the manufacturers who (1) have, at our request, changed their present sets in production to use the standard eight hole pierced type of octal socket; (2) advised us that they have used the standard octal socket in all this year's models; (3) are using standard sockets in all but the rectifier position, or (4) have agreed to follow the RMA Standards on next year's models.

We wish to congratulate the RMA Committee on Broadcast Receivers for their unanimous decision in deeming the eight hole pierced type as the standard octal socket and thank the committee and its chairman, Mr. E. T. Dickey, for their good judgment.

We also thank other manufacturers of test instruments for co-operating with us in eliminating this condition.

Clearly, gentlemen, a perfect example of a new era in American Manufacturing!

Mr. Serviceman—we want you to know that the Supreme Instruments Corporation's efforts to bring your case before the Radio Manufacturers has been successful and through these manufacturers' ready perception of the economic waste such a situation would burden the serviceman with, each one of you will be saved actual dollars on future test equipment!

The Supreme Instruments Corporation takes pardonable pride in this achievement and assures the radio industry that it will continue the endeavor to bring more closely together associated branches of this industry to the end that they may work together more harmoniously for the good of all.

For a full explanation of this situation see Radio Retailing's November Issue.

Yours very truly,

President.

SUPREME INSTRUMENTS CORPORATION,
GREENWOOD, MISS., U.S.A.

- 1—Ansley Radio Corporation
- 2—Atwater Kent Manufacturing Company
- 3—Autocrat Radio Company
- 4—Belmont Radio Corporation
- 5—Consolidated Radio Products Company
- 6—Crosley Radio Corporation
- 7—Electrical Research Laboratories, Inc.
- 8—Emerson Radio & Phonograph Corporation
- 9—Espey Manufacturing Company, Inc.
- 10—Fada Radio & Electric Company
- 11—Fairbanks-Morse Home Appliances, Inc.
- 12—Freed Manufacturing Company, Inc.
- 13—Garod Radio Corporation
- 14—General Electric Company
- 15—Gillfillan Brothers, Inc.
- 16—Hammarlund Manufacturing Company
- 17—The Hallicrafters, Inc.
- 18—Howard Radio Company
- 19—Karadio Corporation
- 20—Kingston Products Corporation
- 21—McMurdo-Silver Corporation
- 22—Midwest Radio Corporation
- 23—Noblitt-Sparks Industries
- 24—Pierce-Airo, Inc.
- 25—RCA Manufacturing Company, Inc.
- 26—Remler Company, Ltd.
- 27—Royale Radio Manufacturing Company
- 28—Sparks-Withington Company
- 29—Stewart-Warner Company
- 30—Stromberg-Carlson Telephone Manufacturing Company
- 31—United Motors Service
- 32—United American Bosch Corporation
- 33—Wells-Gardner & Company
- 34—Westinghouse Electric Supply Co.
- 35—Wilcox-Gay Corporation
- 36—Zenith Radio Corporation

NOTE: There may be other radio manufacturers who (up to closing date) have not advised us that they too are co-operating with the servicemen in this respect. To them we also give our hearty thanks and take this opportunity to wish the whole Radio Industry a Joyous Christmas and a Prosperous New Year.

SHOP SHORTCUTS

by its physical dimensions, efficiency drops off as the receiver is detuned from this frequency.

In control positions 1, 2 and 3 the R9+ antenna is converted into a tuned system. A transformer (there are three of these) is switched into position between the twisted-pair and the set input. And the primary of this transformer may be tuned by means of the shunt 365 mmf. condenser.

Considerable gain in signal strength may be obtained by such tuning. The reason for this is because, as pointed out above, the efficiency of an impedance-matched antenna drops off when it is worked at other than its resonant frequency. At frequencies other than the resonant frequency, in fact, such a system is no longer perfectly impedance-matched and the downleads provide some of the signal pickup. Hence tuning at the bottom of the downleads, now considered part of the entire pickup system, does give some resonant antenna gain. In addition, proper design of the secondaries in a system of this type can provide a better match between doublet leads and input coil than would otherwise occur unless the set had been specifically designed for the low-impedance feeder system doublet.

While careful tuning of the condenser should snap up volume slightly on extremely weak signals use of this control on every station tuned in should not be strictly necessary. It should be sufficient to set the auxiliary control once for each band.

Metal Duplex Diode-Triode

We've been predicting the introduction of a duplex diode-triode in the metal series and the 6Q7 now makes its appearance, significant because there has been some question about the ability of manufacturers to produce multi-purpose types in the new construction.

The 6Q7 has a 6.3 volt, 0.3 amp. heater. Typical conditions for the operation of the triode section as a Class A amplifier (shell tied to cathode) are as follows:

Plate.....	250	100 volts
Grid.....	-3	-1.5
Amplification factor.....	70	67
Plate resistance.....	58,000	84,000 ohms
Mutual.....	1,200	800 inhos
Plate current.....	1.2	0.4 ma.

The tube uses a 7-pin octal base. Connections, looking into the top of the socket, reading clockwise after the locator pin are: cathode, heater, unused, diode, diode, plate, heater, shell. The triode grid is on top.

When resistance coupling the triode the same external plate resistance values may be used as with the type 75. The bias should be about $\frac{1}{2}$ volt more with a 250 volt supply and $\frac{1}{4}$ volt more with a 100 volt supply than when using a 75.

Octal Tube Short Checker

By J. P. Kennedy

A simple device for the determination of internal short circuits or open heater circuits in metal tubes, or meta-glass tubes, may be built from spare parts and an octal socket. A standard, external ohmmeter capable of distinguishing between 9,500 ohms and 10,000 ohms serves as the indicating device.

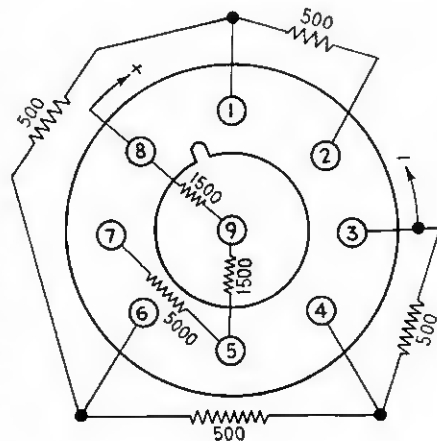

The circuit must be followed closely to insure a complete check of every possible short-circuit in both rectifier and amplifier tubes. In the arrangement illustrated, the ohmmeter must be connected to the terminals designated with arrows on the diagram. If tubes are to be tested while hot, the polarity indicated must be observed or the emission of the cathode will indicate a short circuit.

An open filament or heater will show

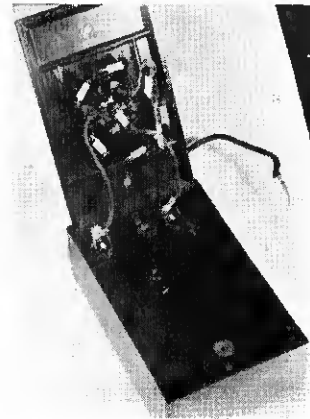

no reading on the meter, a good 5Z4 will be indicated by a reading of 2,000 ohms and all other tubes without internal shorts should produce a reading of 10,000 ohms, the sum of the series resistors.

The important test for possible leakage between cathode and heater accounts for the uneven distribution of resistance in the circuit. The cathode and the heater in the circuit are separated by 8,000 ohms. (Terminals 8 and 7.) As the meter recommended will distinguish between 9,500 and 10,000 ohms, a leakage in parallel with the 8,000 ohm section which would result in a net value of 7,500 ohms would be indicated.

The parts required are as follows:

- 1 Octal tube socket
- 4 500 ohm $\frac{1}{2}$ watt resistors
- 2 1500 ohm $\frac{1}{2}$ watt resistors
- 1 5000 ohm $\frac{1}{2}$ watt resistor
- 2 Pin-jacks and one grid-cap with lead

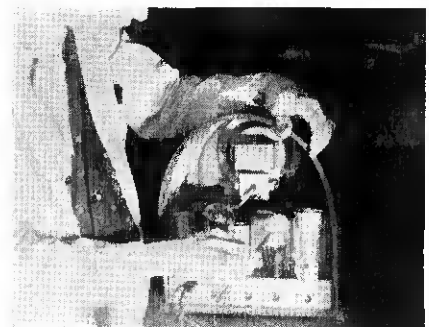
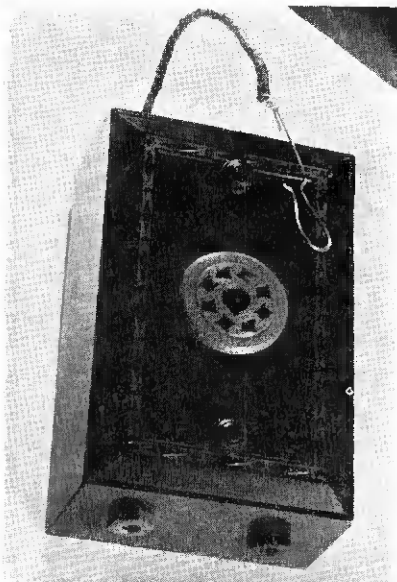

"Tube Knocker"

A sponge-rubber ball, cemented to an 8-inch length of $\frac{1}{4}$ in. Bakelite shaft, is an invaluable shop tool, according to Otto Buder of St. Louis. It is used to knock tubes, condensers and other parts while the set is in operation to isolate noisy components. The other end is cut down for use as an aligning screwdriver.

• **JEFFERSON** •
 Universal Replacement Chart
 { Tells Transformer to Use }
 { on 2000 Different Sets }

Free Chart Simplifies Transformer Replacement

Radio men say "Best thing I ever saw," when they see the new Jefferson Universal Replacement Chart. Hangs on wall—tells at a glance what model Jefferson will duplicate or even improve on the performance of the original transformer in 2000 sets—over 95% of all A. C. sets.

Just as chart simplifies selection and eliminates mistakes, the Jefferson line of transformers solves servicing problems.

Universal filament windings equipped with taps to operate all popular tubes both 2½ or 6.3 volt heaters. Frequently required models made in 4 styles of mounting. Small stock permits immediate service—no waiting for a transformer that will fit. All leads clearly identified—another aid to speedy service without mistakes.

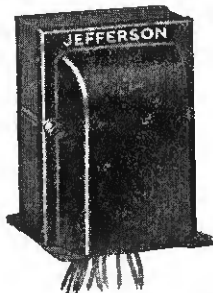

One of the popular styles of housings in which Jefferson Replacement Transformers are assembled.

Make your work easier, speedier, hence more profitable by stocking this remarkably adaptable line.

Mail coupon today for new Chart and Catalog.

JEFFERSON ELECTRIC COMPANY

Bellwood, Illinois
 (Suburb of Chicago)

Canadian Factory:
 535 COLLEGE ST., TORONTO

JEFFERSON ELECTRIC COMPANY
 Bellwood, Illinois

Please mail transformer selection Chart and Catalog.

Name

Address

City State

JEFFERSON *Radio* Transformers

— a Factory rebuild on WESTON Model 682

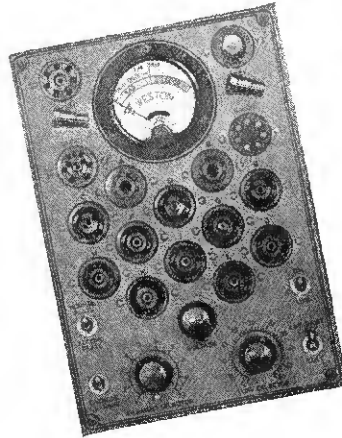

\$9.50

COMPLETE

Bring your Model 682 right up to the minute....

- 1 Equipped for the new metal tubes.
- 2 With improved high resistance Neon short check.
- 3 Completely re-inspected.

—price complete \$9.50 f.o.b. Newark, N.J. Rebuild service also available on other WESTON Tubecheckers . . . Repair Service Dept., Weston Electrical Instrument Corp., 581 Frelinghuysen Avenue, Newark, N.J.

WESTON
Radio Instruments

Radio Parts Specialists

... SUPPLYING 20,000 SERVICE MEN WITH EVERYTHING IN RADIO

• The New Radolek 1936 Profit Guide is NEW! BIGGER! BETTER! The most complete Radio Parts Catalog ever published—it's colossal—gigantic—it's the "top"! Never has there been a Radio Parts Catalog comparable to this superb book. Every page brings you extra profits. Completely revised—right up to the minute, bringing you everything in radio—at the right prices. Over 160 pages of valuable, money-saving "radio-buying" information. Over 10,000 separate Repair Parts—hundreds of new items—a complete new selection of Radio Receivers and Amplifiers. Contains the most complete, exact duplicate, replacement parts listings, of volume controls, condensers, transformers, vibrators ever compiled. This is your book—it's FREE. Send For It!

RADOLEK restricts distribution of the PROFIT GUIDE to those actively and commercially engaged in the Radio Business. Please enclose your Business Card or Letter Head.

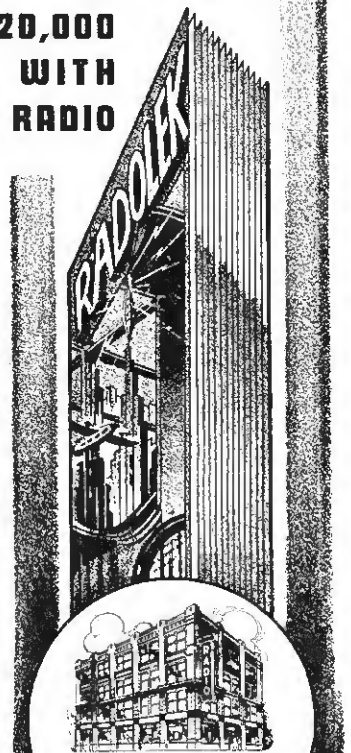

401 West Randolph St. • **RADOLEK** COMPANY • CHICAGO ILLINOIS

HOW TO USE THE "MAGIC-EYE" TUBE AS A SERVICE INSTRUMENT

Principle of 6E5 operation. Explanation of its action as a receiver tuning indicator. Description of an accurate, inexpensive and easily made direct-reading vacuum-tube voltmeter

BY L. C. WALLER AND P. A. RICHARDS

RCA Radiotron Div., RCA Mfg. Co., Inc.

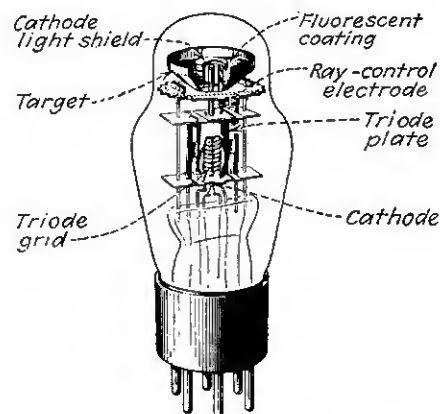

Fig. 1—Cutaway drawing of the 6E5, showing the electrode structure

THE new electron-ray tube type 6E5, perhaps better known as the "Magic Eye," has so many useful applications in servicing that no one engaged in this work can well afford to overlook its possibilities. Because of its relatively insignificant cost, the simplicity and compactness of the auxiliary apparatus required and the numerous practical applications for which it is inherently suited, the 6E5 will undoubtedly soon have the servicing fraternity wondering how they ever got along without it.

The purpose of this article is to show how the 6E5 can be used effectively as a service tool and to point out some of its more important applications, many of which present problems heretofore almost unsolvable unless the serviceman was fortunate enough to possess a cathode-ray oscillograph or a good vacuum-tube voltmeter.

Principle of Operation

A thorough understanding of the manner in which the 6E5 functions is essential if the tube is to be employed to the best advantage. Figure 1 shows its electrode structure and Figure 2 the socket connections. The tube consists essentially of a simple triode above which is located a cone-shaped fluorescent target and a tiny ray-control electrode.

The circuit of Figure 3 will serve to illustrate how the 6E5 operates. If the grid-bias potentiometer (R_1) is set for zero bias (the movable arm at the "plus" end of the potentiometer), the fluorescent pattern viewed from the top of the tube will have a shadow sector of about 100 degrees, as shown in Figure 4. This shadow is cast on the target because the ray-control electrode is at a negative potential with respect to the target; the bias on the ray-control is due to the RI drop across the plate resistor (R_2) when any triode plate current is flowing—this plate current being inversely proportional to the negative bias on the triode grid.

Thus, if the triode-grid bias is changed from zero to some negative value by means of R_1 , the plate current of the triode will decrease, like that of any other triode, the RI drop across R_2 will become smaller, the bias on the ray-control electrode will decrease, and the shadow sector on the target will close up to a smaller angle. With about 6 or 8 volts of negative bias on the triode grid, the shadow sector will close up to a narrow, dark line, as illustrated by Figure 5. Slightly more triode-

grid bias may cause the pattern to close completely, or even "overclose"; in the latter case, the dark line may change into a narrow, luminous line having greater brightness than the rest of the pattern.

Because the variations of the pattern on the target are controlled by the negative bias on the triode grid (see the curves of Figure 6 for the actual relationship), it is at once apparent that we have a negative-grid, voltage-indicating device which, like a vacuum-tube voltmeter, draws no power and hence can be applied to high impedance circuits with little or no loading effect. Here, in brief, is the feature of the 6E5 which makes it of real value as a piece of test equipment.

As a Tuning Indicator

Before special service applications are described, a discussion of the 6E5 in its usual function as a visual tuning indicator in receivers is advisable to completely familiarize servicemen with its operating principle. Figure 7 shows a typical diode-detector and a-v-c system (for it is with receivers having a-v-c. and/or a diode second detector that the 6E5 is of particular value). The control voltage is developed across the diode load resistor (R_1) and fed to the grids of the controlled r-f and i-f stages through the usual filter and time-constant circuit R_2C_2 .

The full a-v-c bias voltage appearing at the end of R_2 would, of course, control

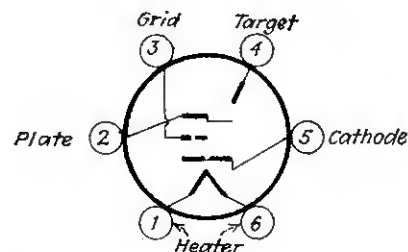

Fig. 2—Bottom view of socket connections

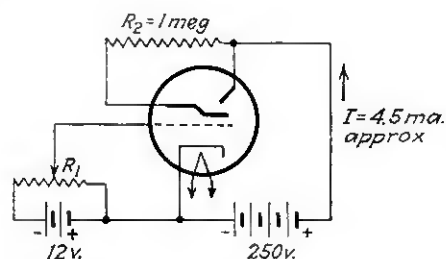

Fig. 3—Simple circuit illustrating principle of operation

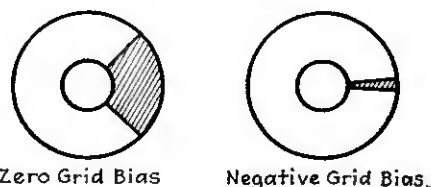

Fig. 4 (left) and Fig. 5—Fluorescent patterns, viewed from the top of the tube

a New Crystal Pick-up by

WEBSTER ELECTRIC



fitting companion
to the well-known
and widely-used
magnetic type . . .

●When the Webster Magnetic Type Pick-up was introduced to the field, its performance characteristics met the approval of the most critical.

The new Webster Crystal Pick-up is destined to receive the same enthusiastic approval.

For this new pick-up embodies the precise design, the engineering skill and the careful craftsmanship so essential to fine performance in sound reproduction apparatus.

The Webster engineers have applied a new adaption of theory in the design of this new pick-up which provides the very ultimate in high frequency response with a minimum of needle noise.

The Webster Crystal Pick-up has many design features—some of which are listed to the right. It is available for use with both standard and 16-inch records in both standard and high fidelity response.

Literature which describes it in detail will be mailed you upon request.

*Licensed under patents of
Brush Development Company*

WEBSTER ELECTRIC COMPANY
Established 1909
RACINE . . . WISCONSIN, U. S. A.
Export Office
15 Laight St., New York City

Wherever Sound **W** Must Fill Great Spaces

WEBSTER ELECTRIC

FEATURES

- 1**
Compact with light needle weight on record.
- 2**
Free from resonance.
- 3**
Lower scratch and distortion level.
- 4**
Low mechanical needle point impedance.
- 5**
Chatter Proof—wear-resisting mechanical construction.
- 6**
Moulded-in screw terminals—no soldering required. (Avoids possible damage to crystal from heat.)
- 7**
Double sealed against moisture.
- 8**
Built-in volume control (or without).
- 9**
Compensated frequency response (standard or high fidelity).
- 10**
Range of voltage output up to 1.5 V. at 1000 cycles.



WIN a CASH PRIZE!

Design an Amplifier Using
CONTINENTAL Carbon Inc.
Resistors and Condensers

\$25.00 1st prize; \$10.00 2nd prize;
10 consolation prizes of \$2.50 each.

- 1—Secure an entry blank and rules of the contest from your distributor or directly from **CONTINENTAL Carbon Inc.** A post-card will bring you full information and the latest **CONTINENTAL** technical bulletins.
- 2—You have only to submit an ink diagram and list of parts as described in the rules of the contest. If you build the amplifier, submit a photograph of it.
- 3—All entries must be postmarked not later than February 28, 1936.
- 4—Use any parts, but all resistors and condensers must be standard **CCI** products.

CONTINENTAL CARBON Inc.

13902 Lorain Ave., Cleveland, Ohio

Toronto, Ontario



FOX SOUND EQUIPMENT CORPORATION



You Can't Fool the Critical Ear

Fox Improved Sound Equipment—the favorite of radio engineers—sells on demonstration and guarantees long, satisfactory service. Write today for catalog, price list and technical data sheets. Earn the greater profits possible with Fox Electro Dynamic Units, Aluminum Horns, Portable P. A. Systems, Aircraft Equipment and Theatre Reproducers.

3120 Monroe Street

Toledo, Ohio, U. S. A.

SERVICE SECTION

the grid of the 6E5. However, if the receiver has considerable r-f gain or if it is tuned to a very strong station, the a-v-c voltage will almost certainly exceed -8 volts. Thus, the pattern on the target would *overclose* and the correct tuning point would not be accurately indicated. To avoid trouble of this sort, it is necessary to connect a high-resistance bleeder (R_3R_4) across R_1 and then tap in the grid lead from the 6E5 at a suitable voltage point.

The total resistance of R_3 and R_4 should be, in most cases, in the order of 4 to 6 megohms, so that the shunting effect on R_1 will be negligible. The resistance values of R_3 and R_4 should, in addition, be so proportioned that on the strongest signal likely to be received the partial a-v-c voltage across R_4 will *just close*, but not overclose, the fluorescent pattern. When this is done, it may be found that the pattern closes but slightly on weak signals.

In more expensive receivers where a separate i-f amplifier channel and a separate diode are used to provide the a-v-c bias, the 6E5 can be operated from the detector diode with better results, because the range of carrier voltage supplied to the second detector is much reduced by the action of the a-v-c circuit.

Indicator For V.T.V.M.

As a valuable piece of test equipment for service work, the 6E5 can be used in several ways; probably the most useful arrangement is that where the 6E5 is used as a voltage indicator in a vacuum-tube voltmeter circuit. A simple v-t voltmeter designed along these lines is shown in the circuit of Figure 8. This device, which has been constructed and subjected to a number of operating tests, has given very satisfactory results.

In order that the v-t voltmeter (here-

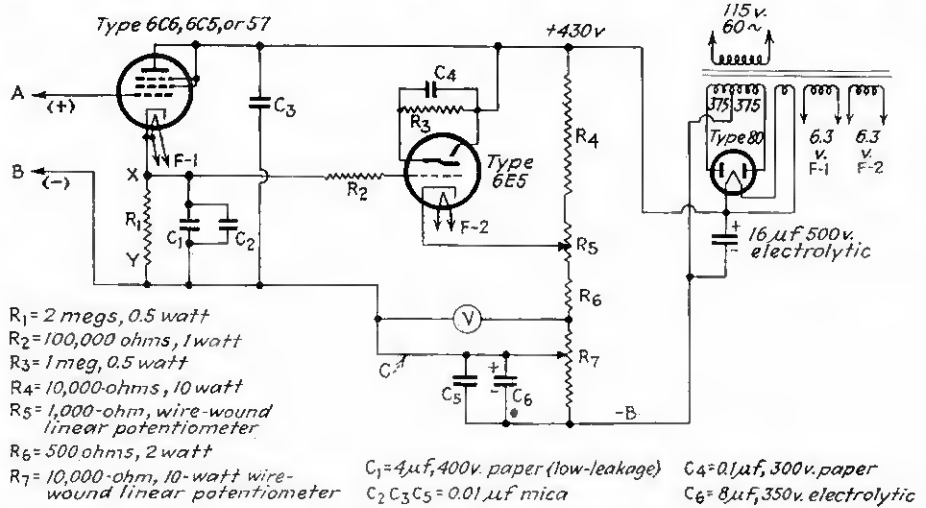

Fig. 8—Vacuum-tube voltmeter circuit useful as a servicing tool, utilizing the "Magic-Eye" tube

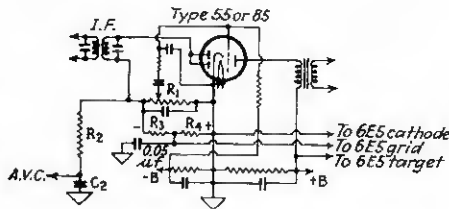

Fig. 7—Circuit showing one method of obtaining negative control voltage for the 6E5. A high-resistance bleeder (R_3, R_4) is connected across the diode load resistor (R_1)

after referred to as "v-t-m", for convenience) can be utilized most effectively, it is necessary that the manner in which it operates be thoroughly understood. Referring to Figure 8, let us assume that the input terminals or test prods A and B are shorted and that the arm of the slide-back potentiometer (R_7) is at the "plus" end of its voltage range. The plate current of the input tube (a type 6C6 was employed in the test model) is practically cut off due to the negative bias applied to the grid from the R_1 drop across the 2-megohm cathode resistor (R_1).

Thus, if it takes about 14 volts of bias to obtain approximate cut off of the 6C6, the cathode end of R_1 (point x) is at a potential of +14 volts with respect to point y. The "zero-reset" potentiometer (R_5) is next adjusted so that the potential difference between the cathode of the 6E5 and point y is about 21 volts, at which setting the bias on the 6E5 grid is approximately -7 volts—the difference between 14 and 21. The pattern on the target will now be closed to a narrow, dark line, which is the correct "zero" setting for all v-t-m measurements.

Now, if the test prods A and B are applied across any d-c or a-c voltage which it is desired to measure, the plate current flowing through R_1 will increase by an amount substantially proportional to the d-c or *peak* a-c voltage, the action being similar to that taking place in a grid-bias detector. In the case of a-c voltages, rectification takes place on the positive half-cycles and the condenser C_2 holds the d-c voltage developed across R_1 at practically the peak value of the a-c wave. Condenser C_1 should be of a *high-quality, low-leakage* type; a *good* paper condenser can be used. The capacity value of C_1 depends on the lowest frequency of the a-c voltages that are to be measured. A value of 4 μf is suitable for frequencies of 60 cycles or higher. In the case of d-c voltages, terminal A of the v-t-m is always connected

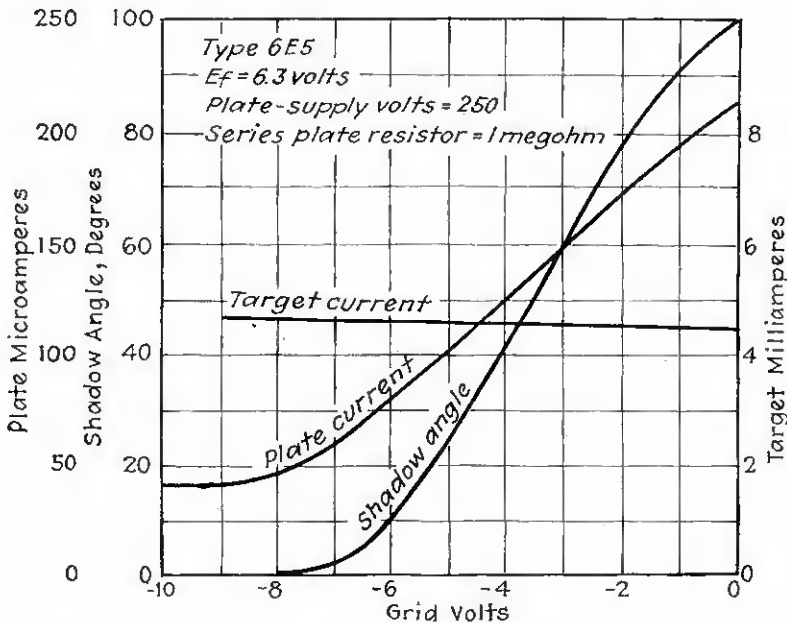
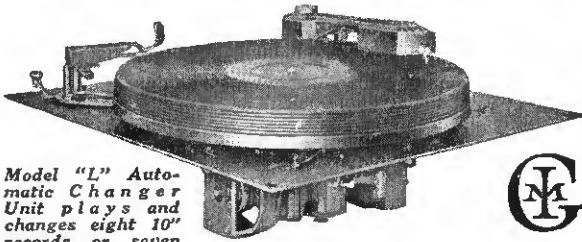

Fig. 6—Average control characteristics

FORGE AHEAD!



Model "L" Automatic Changer Unit plays and changes eight 10" records or seven 12". Repeats last record.



Automatics Are HERE!

GET into the procession now—don't wait until competition forces you to. Sell AUTOMATIC radio-phonograph installations, by using new General Industries low-cost playing units. Motor, pick-up and changer all assembled ready to put in place with practically no labor cost. Precision-built 2-speed FLYER Motor—latest type, silent, steady, adjustable instantly for 33½ or 78 r.p.m. records. Latest, simplified, trouble-proof General Industries changer. Flat-type, fully damped, highly versatile pick-up. Complete units in two types: Model "L"—see above. And Model "K" playing and changing eight 10-inch records; also plays 12-inch, changed by hand. Order samples to test—specifying correct voltage and frequency for your local current.

The GENERAL INDUSTRIES CO.
3537 Taylor St., Elyria, Ohio

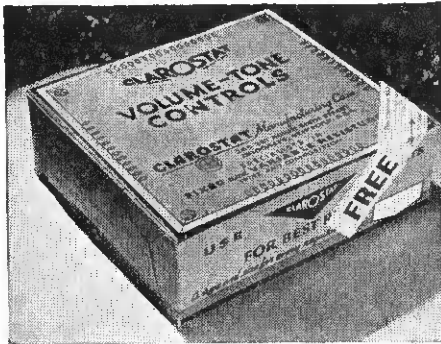

Either Composition or Wire-Wound Control kits.

Kit contains 5 volume controls; 3 Add-a-Switches; 5 flexible resistors.

Attractively packaged in individual cartons and box.

Priced right . . . Composition Kit, \$6.50. Wire-Wound Kit, \$7.00. Less discounts.

VOLUME-CONTROL Kits

Save money three ways: • TIME-SAVING . . . You're always ready to serve most popular sets. • CASH-SAVING . . . You enjoy quantity price on volume controls and switches—and free flexible resistors • LABOR-SAVING . . . genuine "stay put" Clarostat components—no return calls to make good.



Free Manual covers all volume control replacements. Send Clarostat Volume Control carton top to identify yourself as radio man. Meanwhile, stock these new money-saving kits.

CLAROSTAT
MFG. CO., Inc.
285-7 North 6th St. Brooklyn, N. Y.

It's Selling Like Wildfire...

MILLER LINE FILTER

Radio's most efficient line noise eliminator has caught on! Dealers and service men everywhere have discovered this quick money maker.

Take a tip—take a Miller Line Filter with you on every call. Try it on every set. Before-and-after results make a spectacular demonstration. The Filter will sell itself.

Each sale is clear profit for you—there is no installation. Just plug in the Miller Line Filter.

But remember—efficiency is its big appeal, and wound coils plus oil impregnated condensers acknowledged as the best filtering combination known. . . . There is no filter like the Miller.

FREE SILENT SALESMAN color—big market, no contract situation, but small enough to give other dealers a chance.

Phone your jobber NOW, or write Miller today.

\$4.00

J. W. MILLER COMPANY... 5917 SOUTH MAIN STREET... LOS ANGELES

QUALITY recommends

Condensers

by

WET . . . DRY
PAPER
MICA . . . TRIMMER

Please Write for Details
599-601 Broadway
New York City

SOLAR MFG. CORP.

FILTRON ROBOTROL



FOR PERFECT, NOISE-FREE
AUTO RADIO RECEPTION

HERE, at last is the answer to perfect noise-free auto radio reception. The Filtron Robotrol through its special "phase inverting" principle, balances out all spark plug and ignition system noise—eliminates the need of suppressors, etc.

NEW PHASE INVERTING SYSTEM

With the Filtron Robotrol your auto radio will perform like your home radio—and your car will run better because the Filtron Robotrol does not affect ignition spark strength.

AT YOUR DEALER OR DIRECT FROM

Send for Descriptive Literature
Catalog 46-R

CONSOLIDATED
CORPORATIONS
Chicago

SERVICE SECTION

to the positive side of the input circuit.

If we assume that the test prods are placed across a d-c voltage of 10 volts, the potential of point x will be 14 + 10, or +24 volts with respect to point y. The "slide-back" potentiometer (R_7) will then have to be moved toward its negative end until voltmeter "V" indicates 10 volts, before the pattern of the 6E5 will return to the "zero" position (the application of the 10 volts causes the pattern to open, due to the reduction of bias on the 6E5 grid). Thus, the v-t-m will give a direct reading, because the "bucking" voltage introduced by R_7 is always adjusted to just cancel the unknown voltage applied across AB.

The use of the protective grid resistor (R_2) is very important, inasmuch as any voltage above 7 volts across AB will swing the grid of the 6E5 positive. The RI drop across R_2 , caused by grid current in the 6E5, automatically biases the tube so that the grid current can not reach a value high enough to cause trouble.

Accuracy Good

In general, the accuracy of this type of v-t-m will depend upon the precision with which the pattern is adjusted before and after the unknown voltage is applied, as well as upon the accuracy of the d-c voltmeter "V". D-c voltages between 25 and 200 (the latter value being the upper limit of the instrument with the circuit constants shown) can be read to one volt or better, depending mainly on the type of voltmeter used across the slide-back circuit. About plus or minus 0.1 or 0.2 volt is the approximate accuracy of the instrument between 0.5 volt and 10 volts d.c. A-c voltages will give readings which are in error by a fairly constant value of about 0.8 to 1.3 volts, on the low side, due to the characteristics of the 6C6 in this type of circuit. For example, a peak a-c voltage of 1.4 volts gave a reading of 0.6, a peak voltage of 2.8 gave a reading of 1.75, etc. The percentage error is smaller for larger a-c voltages, so that the higher a-c readings are quite accurate.

The error on low values of a-c voltages is not disturbing, inasmuch as the v-t-m can easily be calibrated by means of a variable a-c source of known voltage. The calibration can even be made in terms of RMS values instead of peak values, if desired. It should always be remembered, however, that the voltage indicated by "V" is always in terms of either d.c. or peak a.c. If the peak a-c value is multiplied by the factor 0.707 (assuming fairly good waveform), the v-t-m reading is changed to an RMS value.

Construction Details

The plate supply should preferably be a small powerpack built into the v-t voltmeter unit as a permanent part, especially if the apparatus is to be portable. Inasmuch as the supply has to furnish a current of only 20 ma. (approx.), a very simple

filter is adequate. In most cases, a 16 uf condenser will provide sufficient filtering without resort to a filter choke. If a choke is used, it can be of very small dimensions.

The output voltage of the power supply is necessarily rather high, because about 200 volts are needed across R_4 to operate the target of the 6E5. Another 200 volts or so are used across the slide-back potentiometer (R_7), this voltage being the upper limit which the v-t-m can measure. The other 20 or 30 volts are used across R_5 and R_6 , to provide the initial bias for the 6C6 and 6E5.

If a range of only 100 volts is desired, the power supply voltage can be reduced to about 330 volts. On the other hand, if a range greater than 200 volts is wanted, additional d-c bucking voltage can be inserted in the cathode return lead of the 6C6 at the point marked "C", in Figure 8. Care should be taken so that the bucking voltage never exceeds the particular voltage scale at which "V" is set. The voltmeter "V" is preferably one of the 1000-ohm-per-volt type having three voltage ranges. A voltage calibration can be made for the slide-back potentiometer (R_7) if it is desired to eliminate the d-c voltmeter from the v-t-m. The calibrated potentiometer, however, will not give quite as good accuracy as the voltmeter, especially at low voltages. A low-resistance potentiometer (about 200 ohms) inserted in series with the plus end of R_7 would be of considerable value as a vernier control in the measurement of low voltages, either with the d-c voltmeter or the calibrated potentiometer. Such a vernier was not, however, used in the instrument diagrammed.

Common Shop Uses

Now that we have a vacuum-tube voltmeter which will measure either d.c. or peak a.c. voltages and, because it draws no current from the measured circuit, can

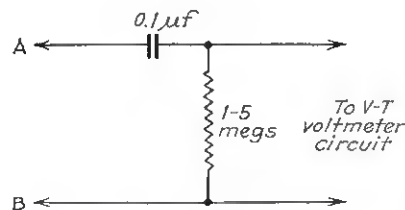

Fig. 9—This auxiliary circuit may be necessary between set and v.t.v.m. when using the instrument as an a.f. output meter, isolating it from d.c.

be used across high-impedance d-c, a-f, or r-f circuits, let us see what we can do with it as a servicing instrument.

The checking of an a-v-c circuit in a receiver is quite simple. Prod B is connected to the cathode of one of the controlled stages and prod A to the low-potential end of the r-f or i-f transformer

secondary. The true bias variation can be accurately measured, either on a broadcast signal or on a signal from a test oscillator (the oscillator does not have to be modulated in this case). The 6E5 can at the same time be used as a visual tuning indicator or as an output meter, inasmuch as the a-v-c voltage will vary as the r-f or i-f circuits are brought into or out of alignment. Under no-signal conditions, the bias can be measured directly between the grid and cathode.

The accurate measurement of d-c grid, screen, and plate voltages is quite simple with the v-t-m, even where a very large series resistance is included in the circuit. For example, the screen voltage of a certain screen-grid r-f or i-f amplifier is supposed to be about 100 volts. A measurement with a 1000-ohm-per-volt meter shows only (say) 50 volts, due to the fact that the screen voltage is obtained through a series resistor and that the voltmeter draws as much or more current than the screen itself. The v-t-m will indicate the true screen voltage, and at the same time probably show up any possible defects in the screen resistor or by-pass condenser. The true plate voltage at the plate of a resistance coupled a-f amplifier can as easily be determined, even if a very large plate-load resistor is employed. Likewise, the grid bias on any a-f stage can be measured directly between the grid and cathode (or filament center tap), regardless of the method in which the bias is obtained.

Intermediate-frequency or r-f transformers can readily be checked in operation by the measurement of the r-f voltage across the secondary winding. The test lead "A" from the grid of the 6C6 should be short and should have as little capacity to ground as possible. The capacity loading introduced by the 6C6 may amount to 5-10 uuf, which will de-tune the circuit under test more or less, depending upon the circuit design. Such de-tuning can be compensated during the test by the adjustment of the trimmer condenser. After the v-t-m capacity load is removed, the trimmer should, of course, be re-set to its original position. If an appreciable amount of r-f testing is contemplated, a 954 acorn tube connected as a triode should be used in place of the 6C6, because the loading introduced by the acorn tube is relatively small.

Where the v-t-m is used as an a-f output meter, the test prods can be applied to almost any part of the a-f circuit. If it is necessary to separate the a-c voltage from a d-c potential which may be associated with it, a 0.1 uf blocking condenser and a 1- to 5-megohm grid leak can be used, as shown in Figure 9. The grid-leak resistance should, in general, be made as small as the permissible loading of the circuit under test will allow. A value of one or two megohms is suitable for most purposes. If the v-t-m is connected between the grid and cathode of an a-f output tube (through a blocking condenser), the instrument will serve both as an output meter and to measure the peak a-f voltage applied to the grid. Low-volume troubles may sometimes be traced to an a-f driving



Dual Midget ELECTROLYTICS



Aerovox P B S midgets in 250 and 525 v. peak ratings.

Wide range of combinations for every need.

Heavy cardboard cases. Thoroughly impregnated. Fully sealed.

With flanges for ready mounting. Break off if not needed.

Colored pigtail leads.

Most capacity for least cost. Least bulk for greatest service.

Two entirely separate sections in one handy unit. Four leads—two positives, two negatives. Most compact yet consistent with safety and long life. Unit shown is 8-8 mfd. 525 v. peak. Compare it with screwdriver alongside! Ideal for AC-DC midget set repairs. Or for crowded assemblies. • Also triple 8 units, slightly larger. • Send for new 1936 Catalog covering complete condenser and resistor line.



AERVOX CORPORATION
74 Washington St. Brooklyn, N. Y.

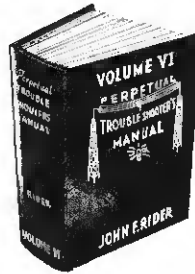

RIDER'S VOLUME VI JUST OUT

DEPENDABILITY. . . . When you own Rider's Manuals, you can depend upon the servicing data in them being correct, up to the minute, and complete.

All good jobbers sell them.

JOHN F. RIDER, Publisher • 1440 Broadway, New York

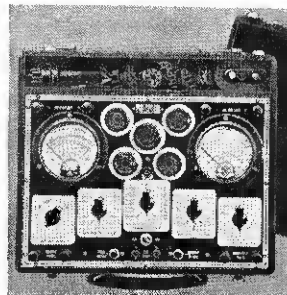

YOUR OBSOLETE ANALYZER MODERNIZED

INTO A TWO METER MASTER ROTARY SELECTIVE SYSTEM

WRITE FOR OUR PLAN { MENTION MODEL NUMBER OF YOUR OLD ANALYZER

Modernization Division—Dept. R

PRECISION APPARATUS CORP.
821 EAST NEW YORK AVENUE BROOKLYN, NEW YORK

INDEX TO ADVERTISERS

Page	Page
Aerovox Corp. 52	Quam-Nichols Co. 41
Aladdin Radio Industries, Inc. 17-18	Radolek Co., The 46
Arcturus Radio Tube Co. 8	RCA Mfg. Co. (Records) 46
Atwater Kent Mfg. Co. 4	RCA Mfg. Co. (Sets) 28-29
Belmont Radio Corp. 4	Readrite Meter Works 42
Clarostat Mfg. Co. 50	Rider, John F. 52
Commercial Investment Trust Corp. 26	Sentinel Radio Corp. 35
Consolidated Wire & Ass'd Corp. 50	Solar Mfg. Co. 50
Continental Carbon, Inc. 48	Stewart-Warner Corp. 3
Cornish Wire Co. 40	Stromberg Carlson Tele. Mfg. Co. 2
Crosley Radio Corp. 40	Supreme Instr. Corp. 44
Emerson Radio & Phono. Corp. 1	Tungsol Radio Tubes, Inc. 5
Fada Radio & Electric Co. 6	Utah Radio Products, Inc. 48
Fairbanks-Morse Home App., Inc. 37	Webster Electric Co. 48
Fox Sound Equipment Corp. 48	Weston Elec'l Instr. Co. 46
Frigidaire Corp. 25	Wincharger Corp. 37
General Electric Co. (Radio) 41	
General Industries Co., The 50	
Gibson Electric Refrigerator Co. 41	
Howard Radio Co. 40	
Hygrade Sylvania Corp. 39	
Jefferson Electric Co. 46	
Ken-Rad Corp. 37	
Miller Co., J. W. 50	
Precision Apparatus Corp. 52	

SEARCHLIGHT SECTION	
Classified Advertising	
Classification	Page
CATALOGS	54
EDUCATIONAL COURSES	
Capitol Radio Engr. Inst.	54
R.C.A. Institutes	54
Sprayberry, F. L.	54
REPAIRS	54
RADIO STOCKS	
Allied Radio Corp.	54
Burstein-Applebee Co.	54
S.O.S. Corp.	54

To sell the SERVICE MARKET

you should have the facts revealed in a recent comprehensive market study made by Radio Retailing. For further particulars drop a line to—

RADIO RETAILING

ABC A McGraw-Hill Publication ABP
330 West 42nd St., New York, N. Y.

SERVICE SECTION

voltage which is too low for satisfactory output.

Measurement of the *gain* of an a-f amplifier stage presents no problem with the v-t-m. It is only necessary to apply a known peak a-f voltage of "E" volts to the grid of the a-f tube and then measure the peak a-c voltage across the plate load. If "E" is 2 volts peak and the voltage at the output is 30 volts peak, the actual gain of the stage is 30/2, or 15. Because there is usually an appreciable d-c voltage drop across the plate load, even if it is a transformer winding (a drop of 6 volts or more is not unusual), the condenser-and-leak system should be connected between the plate load and the 6C6.

Audio and Powerpack Tests

Many times it would be helpful to know definitely the turns ratio of a "spare" interstage a-f transformer which bears no markings. To determine this, place a suitable a-c voltage (from any convenient source) across the primary and measure the peak primary and peak secondary voltage. The ratio of the two peak voltages is substantially the same as the turns ratio of the transformer. Similarly, the accuracy with which a winding is center-tapped can be checked, different resistances of the two halves causing no error.

The wattage output of an audio power stage can be determined with good accuracy by means of the v-t-m and a little arithmetic. A test signal of (say) 400 cycles per second from an audio oscillator having an approximately sinusoidal waveform is applied to the audio system at any convenient point, depending upon the circuit design. This signal is then increased until its peak value at the grid of the final audio tube (or one of the tubes in a push-pull stage) is the maximum permissible for the particular tube and circuit under test (for a tube operating Class A, the peak signal voltage should not exceed the d-c bias voltage). A pure resistance load of the correct value (for example, 7000 ohms for a single 47 pentode) is then shunted across the primary of the output transformer, the speaker load being disconnected. The peak a-f voltage developed across this plate-load resistor is next measured. Taking the case of the single 47 for an example, we shall assume that the measured peak output voltage E_{pk} is 186 volts. Expressed as an RMS value, $E_{rms} = 186/1.41 = 132$ volts. From the relation $P = E^2/R$ we get:

$$P = (132)^2/7000 = 2.5 \text{ watts.}$$

The ripple voltage of high-voltage d-c power supplies can be measured, provided the ripple has a peak value of 0.5 volt or more. The input circuit of Figure 9 must be used, of course, to block off the d-c voltage of the power supply. In addition, the blocking condenser should have a voltage rating high enough to withstand the d-c voltage.

The v-t-m can be used to measure d-c or peak a-c currents, provided a suitable known resistance can be inserted in the circuit under test without disturbing its normal function, and provided enough voltage can be developed across the known re-

sistance to give a satisfactory reading. For example, a 5000-ohm resistor can be placed in the plate circuit of a resistance-coupled a-f amplifier which is drawing about 1 ma. The RI drop measured across the 5000-ohm resistor will measure 5 volts. The current can be determined by Ohm's Law.

Another example of current measurement is the determination of the peak d-c current of a mercury-vapor rectifier. A resistor of about 100 ohms or so is placed in the -B lead of the rectifier, between the filter and the center tap of the high-voltage secondary winding. The v-t-m will measure the peak d-c voltage developed

across the resistor, Ohm's Law giving the peak current in the circuit ($I_{pk} = E_{pk}/R$). Such a measurement will quickly show whether or not the input choke of the filter system is limiting the peak plate current of the rectifier tube to a safe value, as judged by the manufacturer's rating.

The applications of the 6E5 which have been mentioned are only intended to illustrate what can be done with this versatile little tube. The ingenious serviceman will find that the vacuum-tube voltmeter which has been described can be advantageously applied to many other servicing problems. The more familiar he becomes with it the more indispensable he will find it.

TRICKS of the TRADE

AK 30 SERIES. Improving sensitivity, selectivity . . . Replace antenna choke with a compensator coil, a center-tapped coil with one end to grid, one to ground and the tap to the antenna post.

CLARION 220. No reception . . . Often traceable to break in sheath-covered 1,000-ohm wire running between grid clip of detector-oscillator 24A and tuning condenser. Replace with fixed resistor and wire.

CROSLEY 30S, 31S, 33S, 34S. Common trouble which should be checked before wasting time on analysis . . . Sockets readily short to chassis as holes in chassis admitting them are too small for safety.

CROSLEY CHIEF 132. When this 12-tube super plays, but volume is shy and all tubes, voltages check ok . . . Unsolder .0001 condenser between cathode of 56 used as diode detector and 5 meg. resistor and check it for a short. This trouble is difficult to locate and relatively common.

GRUNOW 660, 661, 662. Bad distortion when volume is advanced . . . Suspect high resistance leak in .01 audio coupling resistor, sometimes of the order of 5 megohms. A neon tester will catch this trouble but an ohmmeter will frequently pass it up unless used on an extremely high range.

MAJESTIC 300. Whistling and squealing on each station tuned in, also low volume . . . Generally due to open condenser C10, a .1 mike unit in plates of push-pull detector circuit. Replacing original Majestic tubes in i.f. and r.f. circuits with standards . . . Cover glass of conventional tubes with shellac, then stick tinfoil over glass, forming close-fitting shield. Twist piece of bare copper wire over foil just above tube base and attach to cathode of tube.

MAJESTIC 300A. Volume low, peaking at midpoint of volume control setting . . . Replace .1 condenser in square can. This unit has white rubber covered leads and connects between one end of the volume control and the grid circuits of the r.f. and i.f. tubes. Set plays for moment when first turned on but then quickly chokes off . . . Replace .25 condenser in same can as above, one side grounded, red lead.

PHILCO 70, 70A, 370. Impossible to align circuit at 1400 kc. . . . Look for open .00011 condenser between oscillator coil and plate of oscillator. Replace with .0005 and the set will align and be more selective than originally. Where this trouble exists reception will be ok below 850 kc. but will fall off rapidly at higher frequencies.

RCA "MAGIC EYE." Fluorescent glow crosses over on strong stations, or does not change enough on any station . . . Change value of resistor connected from ray control electrode to ground. Make it larger if the ray crosses, smaller if it doesn't change enough.

RADIOLA 80. Noisy reception is complaint . . . Examine i.f. transformer coupling 1st detector to 1st i.f. stage. This unit has a copper shield disc between its windings. If disconnecting the control grid connection of the 1st i.f. tube does not eliminate the noise replace the transformer. Other transformers sometimes cause similar variety of noise but the one mentioned is the most frequent offender.

STROMBERG 846, 848. Periodic fading, antenna control fails to function properly . . . Check small wire-wound resistor in series with antenna control, in turn shunted across antenna coil. Disconnect resistor and tighten up rivet holding one end.

SEARCHLIGHT SECTION

EMPLOYMENT and BUSINESS OPPORTUNITIES—SURPLUS STOCKS—DISCONTINUED MODELS

UNDISPLAYED—RATE PER WORD:
 Positions Wanted (full or part-time salaried employment only) 7½ cents a word, minimum \$1.50 an insertion, payable in advance. (See % on Box Numbers.)
 Positions Vacant and all other classifications, 15 cents a word, minimum charge \$3.00.
 Proposals, 40 cents a line an insertion.

INFORMATION:
 Box numbers in care of our New York, Chicago and San Francisco offices count 10 words additional in undisplayed ads. Replies forwarded without extra charge. Discount of 10% if one payment is made in advance for four consecutive insertions of undisplayed ads (not including proposals).

DISPLAYED—RATE PER INCH:
 1 inch \$8.00
 2 to 3 inches 7.60 per inch
 4 to 7 inches 7.60 per inch
 Rates for larger spaces, or yearly rates, on request.
 An advertising inch is measured vertically on one column, 3 columns—30 inches—to a page. Radio Retailing

NEW ADVERTISEMENTS RECEIVED UNTIL THE 30TH OF THE MONTH FOR THE ISSUE OUT THE FOLLOWING MONTH.

WANTED—Fully experienced Radio Service Expert. "Screw driver mechanics" need not apply. Must be fast, accurate and thoroughly familiar with all types of modern radio work. A real opportunity for the right man. State qualifications in detail. Box 101, c/o Bulletin.

Could You Fill This Service Job?

Under improved business conditions, dozens of good-paying opportunities will soon be popping up in radio. Your future depends on whether or not you are qualified to grasp them. Will they go to other fellows—or will you **MAKE** them come to you?

Sprayberry Training is designed **NOT** for beginners but for men already in the service business who recognize the need for keeping up-to-date. It is for men who know that, to get better-than-average jobs, they have to be better-than-average workmen. It is sound, practical business and technical training—at a price within the reach of all. Investigate!

LET ME HELP YOU BUILD A REAL SERVICE SUCCESS



F. L. SPRAYBERRY, 2548 University Pl., N. W. Washington, D. C.

Without obligation, send me details on your advanced Service training.

Name

Street

City RR 12-35

SPRAYBERRY'S PRACTICAL MECHANICS OF RADIO SERVICE



Mr. E. H. Rietzke, President of CREI and originator of the first thorough course in **PRACTICAL RADIO ENGINEERING.**

for Servicemen

WHO WANT A FUTURE—

CREI Offers This New Course in

SERVICE AND PUBLIC ADDRESS ENGINEERING

Whether you're the "boss," or hope to be . . . today's intricate radio problems require every serviceman to have a keener knowledge of fundamentals. This new course is for experienced men only, who realize that technical training is necessary for success.

GOOD MEN HAVE GOOD JOBS

Why shouldn't YOU be a "big man" in Service Engineering? This course completely covers Service and Public Address Engineering, plus the latest works in vacuum tubes, circuits, acoustics and treatment of auditoriums.

FREE ILLUSTRATED CATALOG
 Write For Your Copy Today!

RIGHT now—WRITE now for complete information about the course, prices, terms, etc. It costs nothing to hear our story.

★ **CAPITOL RADIO ENGINEERING INSTITUTE**
 DEPT. RR-12
 14TH & PARK ROAD WASHINGTON, D. C.

FREE BULLETIN

1936 RADIO Supply Guide (catalogue)—saddle stitched, 6½"x9½", 116 pages, illustrated, priced and indexed. Write to Allied Radio Corporation, 833 W. Jackson Blvd., Chicago, Ill.

SOUND - ON - FILM EQUIPMENT

New — Used — Rebuilt
 16 mm and 35 mm

Startling low prices on projectors, screens, sound heads, amplifiers, microphones, portable projectors, arc lamps, rectifiers, generators, etc.

Write for details

S. O. S. CORP., 1600 Broadway, New York

SEARCHLIGHT SECTION

Covers the Advertising of

- Agencies Wanted
- Agents Wanted
- Auction Notices
- Bids Wanted
- Books and Periodicals
- Buildings for Sale
- Business Opportunities
- Civil Service Opportunities
- Contracts to Be Let
- Contracts Wanted
- Educational
- Employment Agencies
- Foreign Business
- For Exchange
- For Rent
- Franchises
- Labor Bureaus
- Machinery Wanted
- Partners Wanted
- Patent Attorneys
- Patents for Sale
- Plants for Sale
- Positions Vacant
- Positions Wanted
- Property for Sale
- Proposals
- Receivers Sales
- Representatives Wanted
- Salesmen Wanted
- Second Hand Equipment
- For Sale
- Exchange
- For Rent
- Wanted
- Specialties
- Tutoring
- Miscellaneous For Sale, For Rent and Wanted

Address
 Departmental Advertising Staff
 McGraw-Hill Publications
 330 West 42d Street, New York

PROBLEM ?

Here it is: to find a reliable source for all your radio supplies which will bring you the highest grade merchandise at the lowest prices—and bring it to you fast and accurately.

APPLY —

to solve—**ALLIED'S** 1936 Catalog—Radio's most complete Supply Guide—a real index to radio progress—offered FREE to you by Radio's Leading Supply House.

RESULTS :

Save time—save money—get any part, any brand any time you want it—at the lowest prices—and enjoy ALLIED'S speedy, helpful Personal Service, besides.

ALLIED RADIO
 833 W. Jackson Blvd. Chicago, Ill. Dept. S.E.
 Send me your FREE 1936 Catalog.

Name

Address

FREE

RADIO ENGINEERING

RCA Institutes offers an intensive course of high standard embracing all phases of Radio. Practical training with modern equipment at New York and Chicago schools. Also specialized courses and Home Study Courses under "No obligation" plan. Illustrated catalog on request.

RCA INSTITUTES, INC.
 Dept. RR-35, 75 Varick St., New York
 1154 Merchandise Mart, Chicago
 Recognized Standard in Radio Instruction Since 1909

BIG 1936 WHOLESALE CATALOG FREE



164 pages—Radio, Electrical and Refrigeration Equipment at lowest net prices. A catalog of great value to every dealer, service man and amateur. Complete sets, parts, amateur and commercial apparatus. Write today.

BURSTEIN-APPLEBEE CO.
 1012-14 McGee St., Kansas City, Mo.

PHENOMENAL DEMAND GREETSS CROSLEY'S METAL TUBE MODELS

BUILT FOR METAL TUBES FROM THE
GROUND UP . . . MANY ADVANTAGES

Few, if any, radio manufacturer has given more time and thought than has Crosley to the place of the metal tube in radio manufacturing. Naturally, the moment metal tubes had reached the practical stage, many manufacturers rushed into print announcing metal tube sets. While Crosley was early in the field with metal tube sets, it was with circuits especially developed for metal tubes. The result was that Crosley metal-tube-designed radios—by giving people this latest scientific development at prices they could afford to pay—swept the field. Crosley's fall volume, the greatest in Crosley's history, proves this to be a fact.

Crosley metal tube radio receivers have demonstrated a quality and a performance that have made them popular beyond belief. Due to their small size, metal tubes may be located closer to their ideal position; the shielding is closer to the elements, with greatly improved shielding effect; metal tubes give improved short wave performance; increase the power; they are non-microphonic; vibrationless; unbreakable; give greater selectivity; extreme quietness. In short, their advantages, as demonstrated in the Crosley metal-tube circuits, are tangible and sales-worthy. The models shown here represent the most advanced steps in metal tube practice. Their performance and value give undisputed local leadership to the dealer who is alert enough to see their possibilities.

The Crosley Radio Corporation - Cincinnati

POWEL CROSLEY, Jr., President

Home of "the Nation's Station"—W.L.W.—500,000 watts—most powerful in the world—70 on your dial.

THE CROSLEY A. F. M. (AMERICAN) (FOREIGN) (METAL TUBES)

Incomparably radio's greatest value today. A sensation wherever shown. Cabinet has figured walnut veneer front panel. Chassis is superheterodyne, specially designed for 5 metal tubes. Two tuning bands: American (510-1710 kc) and Foreign (2350-7500 kc). Illuminated airplane type dial. Full floating moving coil electro-dynamic speaker. Many other features.

The A. F. M. is also available in a handsome console, retailing for \$17.50.



\$29⁹⁵

CROSLEY CONSTITUTION CONSOLE

This marvelous radio receiver gives virtual control of whatever is on the air, wherever it may come from! In it are concentrated every one of Crosley's 1936 radio features. Ten metal tubes in a specially designed superheterodyne 5-band all-wave chassis. Among the features: 3-gang tuning condenser with many improvements; new 2-speed dial; new high-wattage metal-to-metal contact tone control; new triple-tuned i. f. transformer; new shadow tuning; new 5-color airplane dial; new color band designation.

Prices in Florida, Rocky Mountain States and West, slightly higher.



\$125⁰⁰

OTHER CROSLEY METAL TUBE MODELS



OLYMPIA
Six metal tube superheterodyne; 3 tuning bands; American, police-amateur-aviation, and foreign broadcast. TABLE MODEL \$45.00
CONSOLE \$59.95



MERRIMAC
Eight metal tube superheterodyne; 3 tuning bands; American, police-amateur-aviation, and foreign broadcast. TABLE MODEL \$65.00
CONSOLE \$89.95



MONITOR
Eight metal tube all-wave superheterodyne; Five tuning bands. Many extraordinary features. TABLE MODEL \$77.50
CONSOLE \$97.50



CONSTITUTION
Console model is described above. This is the finest receiver—both as to chassis and cabinet—in the 1936 Crosley line. 10 tubes, 6 tuning bands. TABLE MODEL \$99.95

WHATEVER HAPPENS . . . YOU'RE THERE WITH A CROSLEY

CROSLEY RADIO

WISE DEALERS SELL THE FIVE STAR FEATURE



Metal Tubes

A sensational development of the General Electric "House of Magic." Small and sturdy, the new metal tubes are self-shielding and so efficient in operation that they make possible receivers which provide efficiency and enjoyability hitherto thought impossible.



Sentry Box

Controls as many as five separate broadcasting bands, but selects and allows only one wave to pass. All coils are rigidly mounted directly on the switch points—completely eliminating all wire leads. This construction, plus complete individualized shielding, results in greater stabilized performance.



Permaliners

Air trimmer condensers that maintain permanently the factory alignment of all circuits. They keep the receiver always at "concert pitch," year in and year out.



Stabilized Dynamic Speaker

Reproduces every word of speech, every note of music with amazing fidelity. A new G-E projection welding process assures permanent and perfect alignment of all speaker parts.



Sliding-Rule Tuning Scale

It lists all stations in a straight line, using a separate scale for each band. "Easy to read as a ruler"—because only one band is visible at a time. Station tuning is further simplified by "automatic vernier tuning," a unique arrangement regulating fast or slow motion from a single knob.



SELL General Electric Radio

It's truly sensational the way General Electric Radio is going over this season, proving that real value tells and sells.

General Electric's success is a result of constantly building *plus* values into every product that carries the G. E. Monogram. That's why, when General Electric decided to manufacture its own receiving set, research engineers of the General Electric "House of Magic" were first given the task of discovering new values in the radio art. The metal tube, a development of General Electric research and engineering, is but one of five spectacular features in General Electric Radio. Together, these star features give a new public consciousness to radio reception.

The display illustrated above has been designed to help dealers effectively present the five star features of General Electric Radio to the

buying public. The rich metal-foil, black and orange lettering, cut-out cards—attached to an orange pedestal stand—give an exceptional, "dressy" appearance to window displays. This display is equally effective, when used inside the store, for making more sales. It's one of a series of unusually striking sales-promotion pieces offered to General Electric Franchised Dealers in the most complete and effective advertising and sales-promotion program we have ever offered.

General Electric Company,
Bridgeport, Conn.
Attention: Section R-1112
Please let me know more about the 1936
General Electric Radio line, and your
sales promotion program.

Name.....
Street.....
City..... State.....

GENERAL ELECTRIC RADIO

MERCHANDISE DEPARTMENT, GENERAL ELECTRIC COMPANY, BRIDGEPORT, CONNECTICUT